

Headrest Pads

OTTO BOCK HEADREST PADS

The OB Series' molded headrests are ergonomically formed and are valued for their robust performance and an economical price.

The OB Headrest is constructed with a metal shell, layered with closed cell foam and coated with a durable rubber casing. Perfect as a transport headrest, a temporary solution, or individuals who rarely rely on a headrest

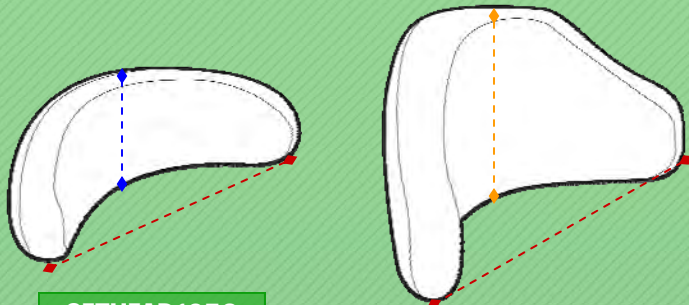

SETHEAD1053

(STL-0TSM250)

SETHEAD1053

(STL-0TLG150)

DIMENSIONS

Width—10"
Height—3.5"
Height—6"

STEALTH ULTRA HEADREST PADS

Whether used as a standalone headrest or as part of a larger system, the Comfort Plus provides multiple options for switch sites, lateral facial devices, attachment hardware etc. Luxurious comfort and a sleek design make the Comfort Plus a favorite.

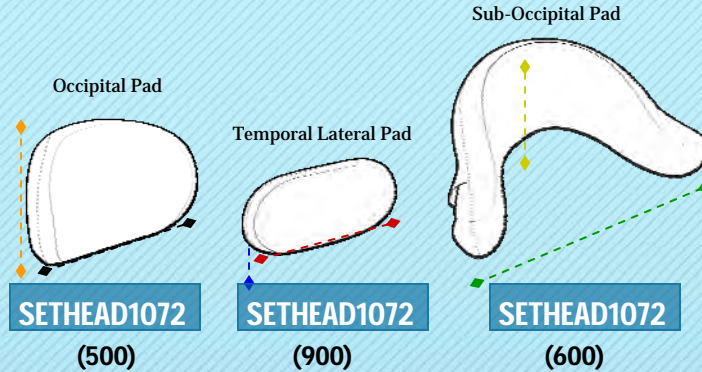

DIMENSIONS

Height—3.75"
Height—2"
Height—2.75"
Width—6"
Width—4.5"

HEADREST HARDWARE

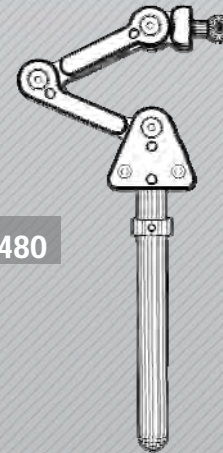

TWB480

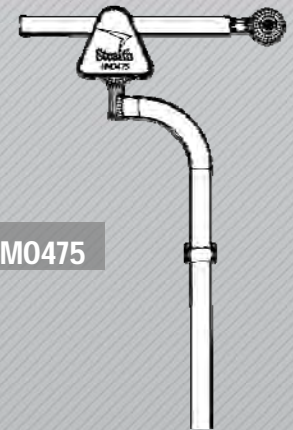

HM0475

The Worlds Best Link Hardware is available for all headrests. Consists of 3/4" round stem with anti-rotation notch, TWB Triangle + Links with set screws for increased stability, and mounting ball.

Multi-Axis Hardware is available for all headrests. Consists of 1/2" square tubing with posterior offset, Triangle Clamp and Horizontal bar for headrest mounting.

STEALTH COMFORT PLUS HEADREST PADS

Whether used as a standalone headrest or as part of a larger system, the Comfort Plus provides multiple options for switch sites, lateral facial devices, attachment hardware etc. Luxurious comfort and a sleek design make the Comfort Plus a favorite.

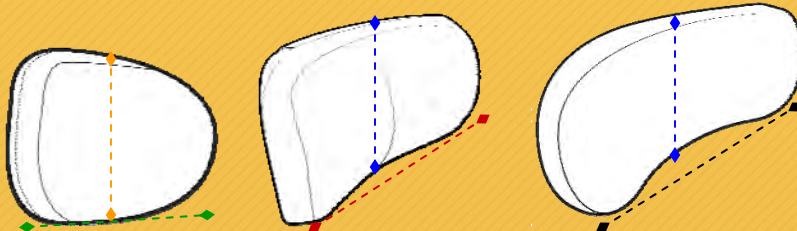

DIMENSIONS

Width—10"
Width—14"
Width—6"
Height—6"
Height—4"

SETHEAD1069

(CPN350)

SETHEAD1057

(CP250)

INDPART2327

(CP150)

Ultra, Combo, i2i, AP

INDPART2715 (SUS9-B-HWD)

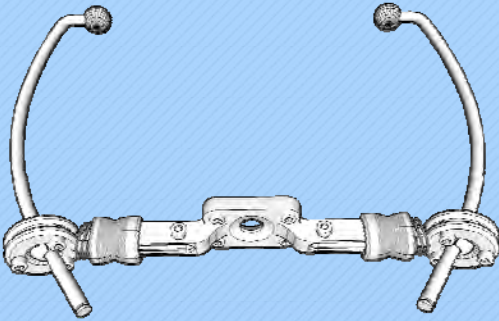

Swing Away component for Stealth Ultra/I2I/Combo/AP headrests:

Both sides swing away—hardware only.

INDPART2650 (SUS9-B)

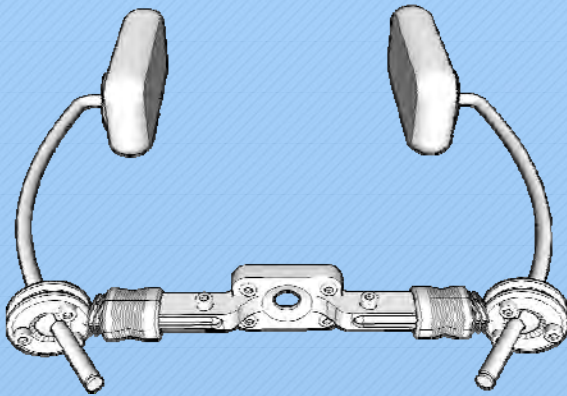

Swing Away component for Stealth Ultra/I2I/Combo/AP headrests:

Both sides swing away with 900 Pads

Comfort Plus

INDPART2648

INDPART2647

CPS9-L

CPS9-R

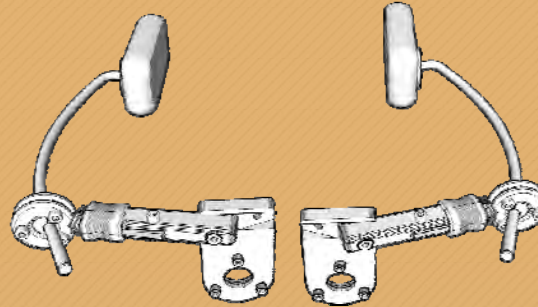

Swing Away component for the Comfort Plus series headrest:

Left or Right side with 900 Pad

INDPART2649 (CPS9-B)

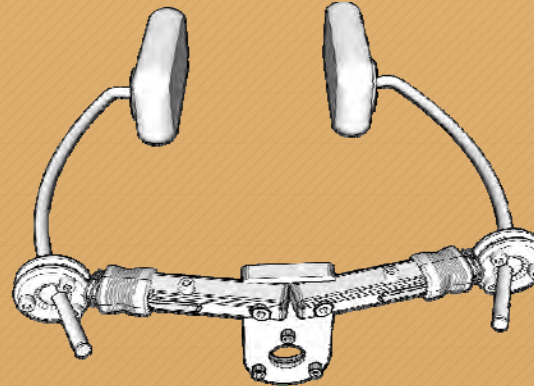

Swing Away component for Comfort Plus series headrests:

Both sides swing away with 900 Pads

Clinical Guidelines

Swing Away Arms offer a sleek, unobtrusive design while featuring an easy, one hand release mechanism for swinging pads and switches back a full 100 degrees. This ensures convenience and is important for transfers, therapy and fatigue issues. Swing-Away pads or switches can be quickly and easily locked back into their original position.

More information available at www.stealthproducts.com

Otto Bock

FRMASMB8306 (OTTOS9-R-SM)

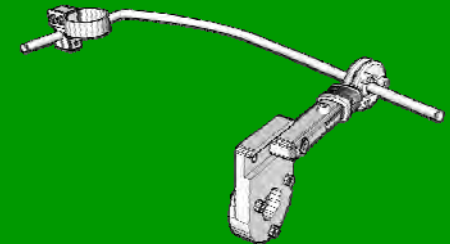

Swing Away component for Otto Bock headrests:
Right Side swing away with ASL MEC Joystick Mount.

FRMASMB8305 (OTTOS9-R-ESM)

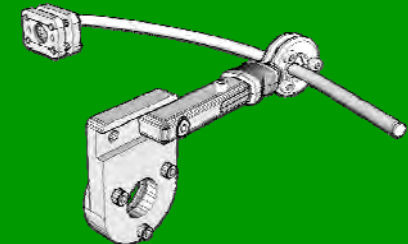

Swing Away component for Otto Bock headrests:
Right Side swing away with Egg Switch Mount.