

Stealth Products[®]



INSTALLATION MANUAL



ADI Disc Brake Systems

Installation Manual for HA-42 Disc Brake
Hub Assembly

Stealth Products strives for 100% customer satisfaction. Your complete satisfaction is important. Please contact us with feedback or to suggest changes that may help improve the quality and usability of our products. You may reach us at:



Stealth Products, LLC
104 John Kelly Drive
Burnet, TX 78611

Phone: (512) 715-9995
Fax: (512) 715-9954
info@stealthproducts.com

Toll Free: (800) 965-9229
Toll Free: (800) 806-1225
www.stealthproducts.com

General

Read and understand all instructions prior to the use of the product. Failure to adhere to instructions and warnings in this document may result in property damage, injury, or death. Product misuse due to failure to adhere to the following instructions will void the warranty.

Immediately discontinue use if any function is compromised, if parts are missing or loose, or if any component shows signs of excessive wear. Consult with your supplier for repairs, adjustments or replacements.

Important Information!

All persons responsible for fitting, adjustment, and the daily use of devices discussed in these instructions must be familiar with and understand all safety aspects of the devices mentioned. In order for our products to be used successfully, you must:

- read and understand all instructions and warnings;
- maintain our products according to our instructions on care and maintenance; and
- ensure devices are installed and adjusted by a trained technician.

All programming and configurations **MUST** be completed by a trained technician.

This manual contains programming instructions and statements meant to be followed by trained technicians.

Supplier Reference

Supplier: _____

Telephone: _____

Address: _____

Purchase Date: _____

Model: _____

These installation instructions will guide you through your product's options and possibilities.

Instructions are written with the expressed intent of use with standard configurations. They contain important safety and maintenance information, as well as describe possible problems that can arise during use. For further assistance, or more advanced applications, please contact your supplier or Stealth Products at (512) 715-9995 or toll free at (800) 965-9229.

Always keep the operating instructions in a safe place so they may be referenced as necessary.

All information, pictures, illustrations, and specifications are based on the product information that was available at the time of printing. Pictures and illustrations shown in these instructions are representative examples and are not intended to be exact depictions of the various parts of the product.

CAUTION

These products are designed to be fitted, applied, and installed exclusively by a healthcare professional trained for these purposes. The fitting, application and installation by a non-qualified individual may result in serious injury.

Ordering Documentation

You can download additional copies of this user manual by accessing the Stealth website (<https://stlpro.site/stealth-docs>) and searching "ADI Disc Brake System Installation Manual" in the search bar at the top of the page.

Our products are designed, manufactured, and produced to the highest of standards. If any defect in material or workmanship is found, Stealth Products, LLC will repair or replace the product at our discretion. Any implied warranty, including the implied warranties of merchantability and fitness for a particular purpose, shall not extend beyond the duration of this warranty. Stealth Products, LLC does not warrant damage due to, but not limited to:

- misuse, abuse, or misapplication of products; and/or
- modification of products without written approval from Stealth Products, LLC.

Any lack or alteration of serial number, where applicable, will automatically void this warranty.

Stealth Products, LLC is liable for replacement parts only. Stealth Products, LLC is not liable for any incurred labor costs.

No person is authorized to alter, extend, or waive the warranties of Stealth Products, LLC.

Stealth Products, LLC warrants against failure due to defective materials or workmanship:

Covers: 2 years

Hardware: 5 years

Electronics: 3 years

In Case of Product Failure

In the event of product failure covered by our warranty, please follow the procedures outlined below:

1. Call Stealth Products at (512) 715-9995 or toll free at (800) 965-9229.
2. Request a Return Authorization (RA) form from the Returns Department and follow department documentation instructions.

1.0 Customer Satisfaction	i
2.0 Important Information.....	ii
3.0 Introduction	iii
4.0 Warranty	iv
5.0 Table of Contents	v
6.0 Warning Labels.....	vii
6.1 Warning Labels	vii
6.2 Limited Liability.....	vii
6.3 Testing	vii
7.0 Design and Function.....	1
7.1 Intended Use	1
7.2 Features	1
8.0 Compatibility.....	2
8.1 Disc Brake Compatibility Information.....	2
8.2 Wheel Compatibility	2
8.3 Chair Compatibility.....	3
9.0 Parts and Accessories	4
9.1 Disc Brake Package Components	4
9.2 HA-42 Disc Brake Kit.....	4
9.3 Brake and Lever Torque Specifications.....	6
9.4 Brake Lever Kits.....	7
9.41 Variable Lever Kit.....	7
9.42 Para Lever Kit.....	9
9.43 Variable Lever Kit.....	11

10.0 Installation Information.....	13
10.1 Preparations	13
10.2 Tools.....	13
10.3 Installation Plan.....	13
10.4 Brake Installation Instructions: HA-42.....	14
10.5 Lever Kit Installation Instructions.....	19
10.51 Variable Lever Kit Installation Instructions	19
10.52 Para Lever Kit Installation Instructions.....	26
10.53 Attendant Lever Kit Installation Instructions.....	34
11.0 Caliper Adjustments	42
12.0 First-Time Use	44
12.1 Dealer Assistance	44
12.2 User Testing	44
12.3 Conditions of Use.....	44
13.0 Maintenance.....	45
13.1 Cleaning	45
13.2 Disinfecting.....	45
13.3 General Maintenance.....	45
14.0 Notes.....	46

Warning Labels

6.1

Warnings are included for the safety of the user, client, operator, and property. Please read and understand what the signal words **DANGER, WARNING, CAUTION, NOTICE** and **SAFETY** mean, and how they could affect the user, those around the user, and property.

DANGER

Identifies an **imminent** situation which, if not avoided, may result in **severe injury, death, and/or property damage**.

WARNING

Identifies a **potential** situation which, if not avoided, may result in **severe injury, death, and/or property damage**.

CAUTION

Identifies a **potential** situation which, if not avoided, may result in **minor to moderate injury and/or property damage**.

NOTICE

Identifies important information not related to injury, but possible **property damage**.

SAFETY

Indicates steps or instructions for safe practices, reminders of safe procedures, or important safety equipment that may be necessary.

Limited Liability

6.2

Stealth Products, LLC accepts no liability for personal injury or damage to property that may arise from the failure of the user or other persons to follow the recommendations, warnings, and instructions in this manual.

Stealth Products, LLC does not hold responsibility for final integration of final assembly of product to end user. Stealth Products, LLC is not liable for user death or injury.

Testing

6.3

Initial setup and driving should be done in an open area free of obstacles until the user is fully capable of driving safely.

Intended Use

7.1

ADI's disc brake systems are intended to be used as brake systems for manual wheelchairs. They are designed to attach to the camber tube region of the wheelchair and slow/stop the wheelchair upon brake lever activation.

Disc brakes offer a method of slowing or stopping a chair independent of tire pressure or wear, reduce upper body fatigue, augment user control, and afford users of all physical abilities near-effortless braking abilities.

Requiring substantially less pressure to activate (1-2lbs of pressure versus roughly 20lbs required for wheel-lock brake systems), disc brake systems are ideal for users with impaired trunk control and/or nonfunctional tricep strength. Additionally, ADI's systems offer multiple brake lever options and configurations tailored to meet the needs of users with a) right, left or bilateral upper extremity weakness; b) impaired hand control; or c) users who have undergone a right or left upper extremity amputation.

Features

7.2

ADI's disc brake systems offer three different types of brake actuation methods:

- Variable
- Para lever
- Attendant lever

Additionally, ADI's disc brake systems offer model-specific 0°, 2°, and 4° camber degree options, as well as direct-mount or spline-insert options for select configurations.

Disc Brake Compatibility Information

8.1

ADI's disc brake systems are compatible with varying chair, mount, and wheel configurations. To ensure the brake system you've ordered is the correct system for your setup, please refer to the charts in the following sections.

Wheel Compatibility

8.2

Please refer to the chart below for wheel compatibility information:

<i>Make/Model</i>	<i>Compatibility</i>
<i>ADI Sun Fusion 16 DB Series</i>	Disc-Brake Ready
<i>ADI Sun Fusion 16 DM Series</i>	Direct Mount
<i>Spinergy SPOX</i>	Requires Spline Drive Insert
<i>Spinergy LX</i>	
<i>Round Betty Dino</i>	

Chair Compatibility

8.3

Please refer to the chart below for chair compatibility information:

Brake Kit	Chair Make	Chair Model	Camber/Mount Options
HA-10	Motion Composites	<i>Apex</i>	0°, 2°, 4° camber tilt
	Sunrise/Quickie	<i>Zippie</i>	
		<i>Q7</i>	
	TiLite	<i>Twist</i>	
		<i>Zr</i>	
		<i>ZRA</i>	
		<i>TR</i>	
		<i>TRA</i>	
		<i>TR3</i>	
		<i>Aero Z</i>	
		<i>Aero T</i>	
HA-12	Ki Mobility	<i>Rogue</i>	
HA-14		<i>Little Wave</i>	
HA-18	Invacare	<i>Solara</i>	Direct Mount
HA-26	Ki Mobility	<i>Focus</i>	
HA-34	Sunrise/Quickie	<i>Iris</i>	
HA-42	Pride	<i>Litestream</i>	

Disc Brake Package Components

9.1

This disc brake package contains a brake kit and a lever kit.

HA-42 Disc Brake Kit

9.2

Below is a basic diagram of components included with the HA-42 disc brake kit:

HA-42 DISC BRAKE KIT

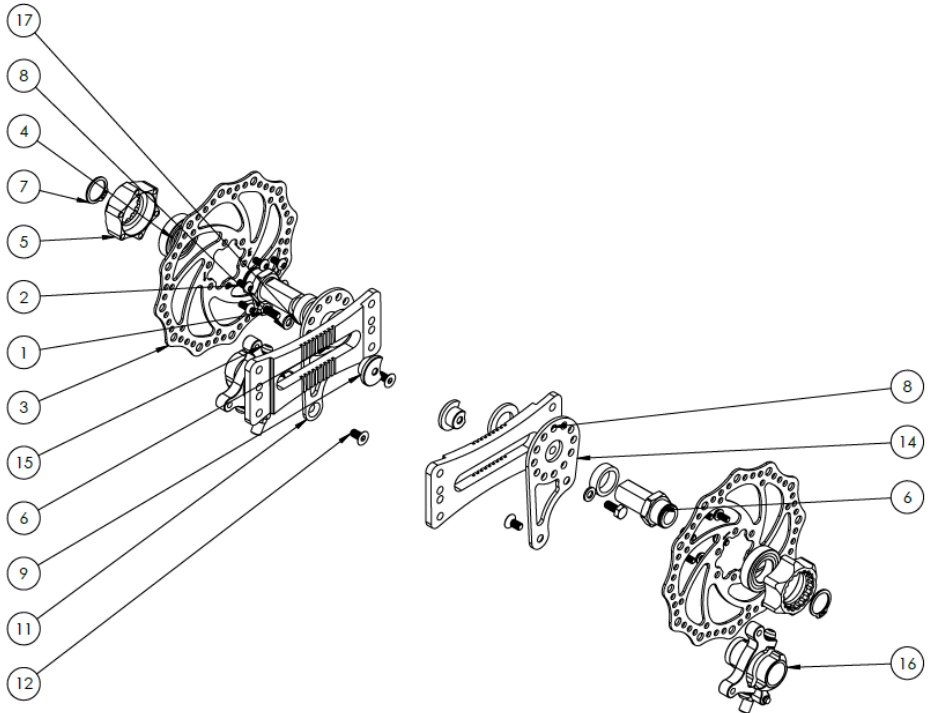

Item No.	Part	Qty.
1	Screws (M6; 1mm pitch, 15mm length)	2
2	Torx Cap Screws (M5x0.80 X 10mm)	12
3	Rotor Discs	2
4	Bearings	2
5	Camber Tube Disc Hubs	2
6	Threaded Axle Inserts (3/4"-16)	2
7	Retaining Rings	2
8	Flat Washers (M6)	2
9	Anchor Plugs	2
11	Universal Caliper Bracket (Right)	1
12	Screws (M6x1; 12mm length)	4
14	Universal Caliper Bracket (Left)	1
15	Caliper (Right)	1
16	Caliper (Left)	1
17	Spacers (.300")	2

BASIC CALIPER COMPONENTS

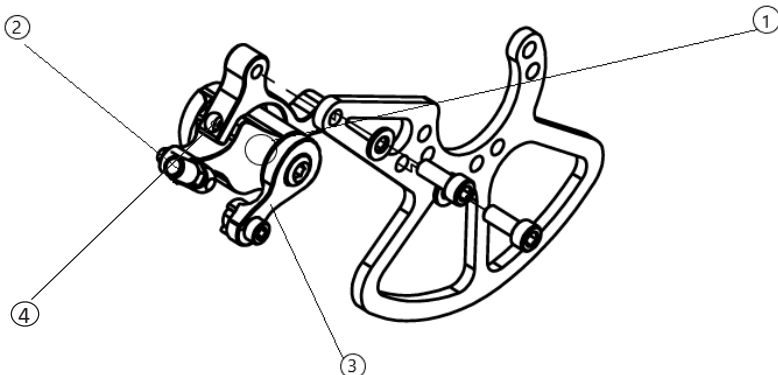

	Part	Description	Qty.
1	Caliper	Compresses brake pad	1
2	Cable Input Ferrule	Houses brake cable	1
3	Moving Arm (Caliper)	Engages brake cable	1
4	Adjustment Bolts	Adjust caliper positioning	2

Brake and Lever Torque Specifications

9.3

Hardware	Torque Specifications
<i>6mm</i>	8.7 N•m
<i>5mm</i>	5.1 N•m
<i>4mm</i>	2.6 N•m
<i>10-32</i>	31.7 lb-in

Brake Lever Kits

9.4

ADI's disc brake packages will include a Variable, a Para, or an Attendant brake lever kit. Check to ensure you have received the correct lever kit before installation.

Variable Lever Kit

9.41

VARIABLE LEVER ASSEMBLY

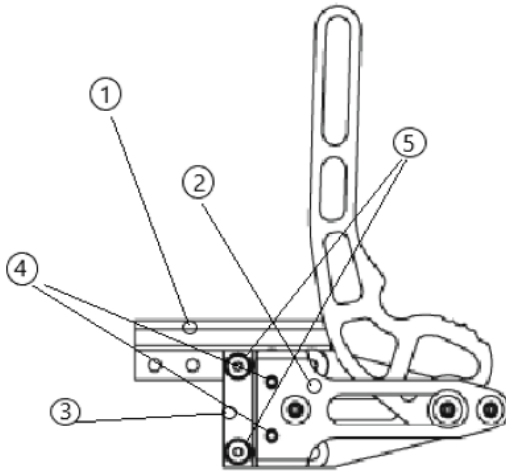

	Part	Description	Qty.
1	<i>Lever Adjustment Bar</i>	Attaches lever assembly to frame clamp	1
2	<i>Cable Block</i>	Seats and secures brake cables	1
3	<i>Cable Housing Clamp</i>	Seats and secures cable housing	1
4	<i>Cable Block Set Screws</i>	Tighten to secure brake cables	2
5	<i>Cable Housing Clamp Screws</i>	Tighten to secure cable housing	2

VARIABLE LEVER BRAKE CABLES AND HOUSING

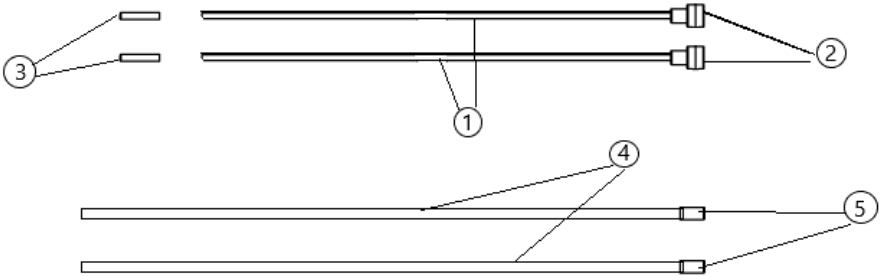

	Part	Description	Qty.
1	<i>Brake Cables</i>	Connect disc brake calipers to lever system	2
2	<i>MTB Brads</i>	Cap and help seat brake cables	2
3	<i>Metal End Caps (Cables)</i>	Crimped to prevent brake cable wear/unraveling	2
4	<i>Brake Cable Housing</i>	Houses and protects brake cables	2
5	<i>Metal End Caps (Housing)</i>	Cap and help seat cable housing	2

Para Lever Kit

9.42

PARA LEVER ASSEMBLY

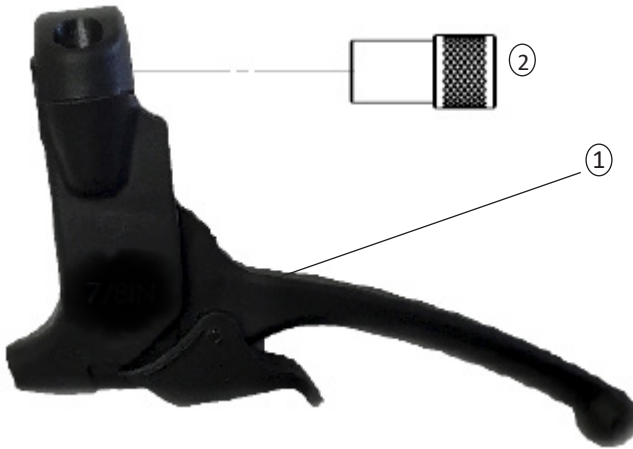

	Part	Description	Qty
1	<i>Lever</i>	Engages brake system	2
2	<i>Lever Adapter Insert</i>	Enables cane compatibility	2

PARA LEVER BRAKE CABLES AND HOUSING

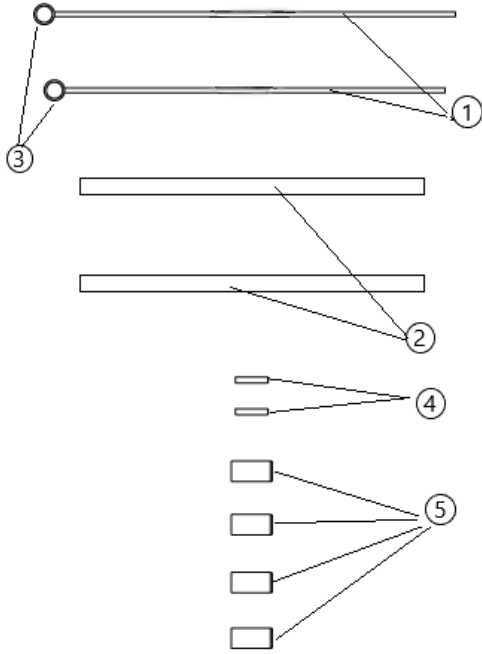

	Part	Description	Qty.
1	<i>Brake Cables</i>	Connect disc brake calipers to lever system	2
2	<i>Brake Cable Housing</i>	Houses and protects brake cables	2
3	<i>MTB Brads</i>	Cap and help seat brake cables	2
4	<i>Metal End Caps (Cables)</i>	Crimped to prevent cable wear/unraveling	2
5	<i>Metal End Caps (Housing)</i>	Cap and help seat cable housing	4

Attendant Lever Kit**9.43****ATTENDANT LEVER ASSEMBLY**

	Part	Description	Qty
	<i>Lever</i>	Engages brake system	2

ATTENDANT LEVER BRAKE CABLES AND HOUSING

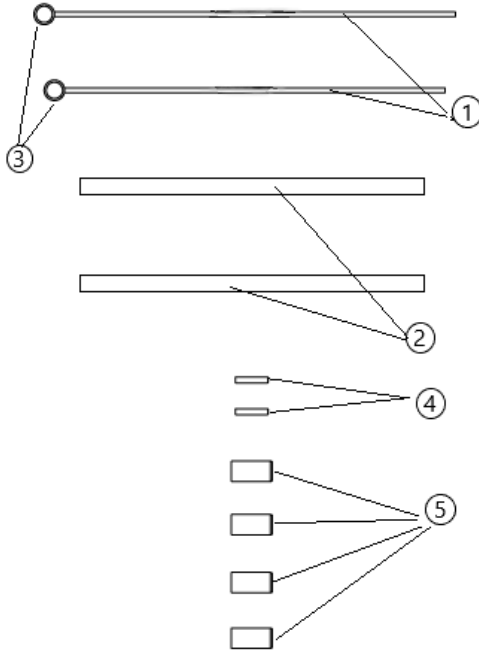

	Part	Description	Qty.
1	<i>Brake Cables</i>	Connect disc brake calipers to lever system	2
2	<i>Brake Cable Housing</i>	Houses and protects brake cables	2
3	<i>MTB Brads</i>	Cap and help seat brake cables	2
4	<i>Metal End Caps (Cables)</i>	Crimped to prevent cable wear/unraveling	2
5	<i>Metal End Caps (Housing)</i>	Cap and help seat cable housing	4

Preparations

10.1

Only a qualified service technician may install ADI disc brake systems.

WARNING

An incorrect installation of the brake system or its accessories may cause damage to the hardware and/or injury to the user.

Tools

10.2

Use the proper tools to install and adjust the ADI disc brake system to the desired position for the user. Ensure all torque specifications are followed.

CAUTION

The use of improper tools may damage the device. Not tightening to the torque specification can cause components to fail or cause the user discomfort.

Installation Plan

10.3

Set up an installation plan before beginning the installation. This plan should take into account:

- where the brake actuator lever will be placed;
- how the disc brake system will be operated; and
- the amount of necessary clearance for other hardware and accessories.

CAUTION

Any connection must always be secured with all delivered screws. Only use the screws provided in the package.

Brake Installation Instructions: HA-42

10.4

REQUIRED TOOLS:

- Adjustable crescent wrench
- Hex keys: 2.5mm, 3mm, 5mm, 7/32", 3/32", 3/16"
- Pliers

Step 1: Use a tape measure to take original measurements of the wheelchair's delivered arrangements. Determine permanent position of chair with end user before installation, factoring in center of gravity, seat height, etc.



Step 2: Remove the rear wheels and loosen the axle receivers using a 1 1/8" wrench or socket wrench.



- *To ensure the proper location of reinstallation, note the position of the axle receivers before removal.*

Step 3: Working one side at a time, place each 3/4"-16 threaded axle insert provided through each .300" spacer, then through the corresponding caliper bracket. Install the arranged parts onto the slotted axle plates using the OEM positioning washers and 3/4"-16 slim lock nuts.

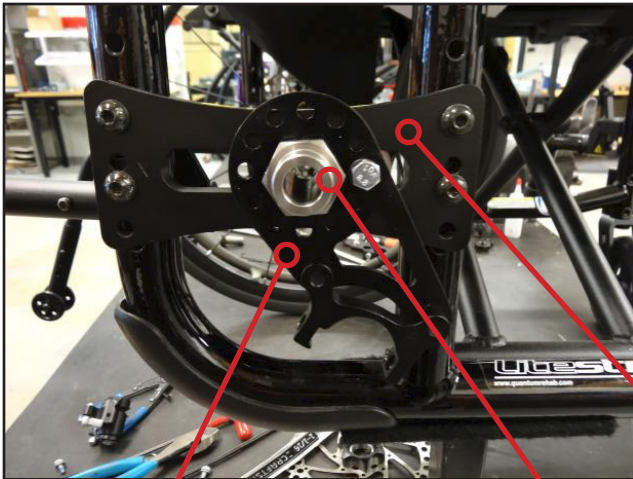

- *Position the caliper/caliper bracket and axle receiver assembly at an angle that gives the caliper ample room to operate and room for the cable to enter the caliper without too sharp of a bend.*

Caliper
bracket

Threaded axle
insert

Slotted axle
plate

Step 4: Having determined the best positions for the calipers, use a 10mm wrench to attach the anchor plugs provided.



Anchor plug

Step 5: Detach the caliper from the caliper's "U"-shaped bracket by using a 5mm hex key to remove both adjustment bolts.

Step 6: Tighten the OEM 3/4"-16 slim lock nut using a 1 1/16" wrench or socket wrench.



Step 7: Place each caliper over its corresponding rotor disc and simultaneously slide both parts onto the slotted axle plate and the caliper's "U"-shaped bracket.



Step 8: Secure the rotor assemblies with the retaining rings provided.

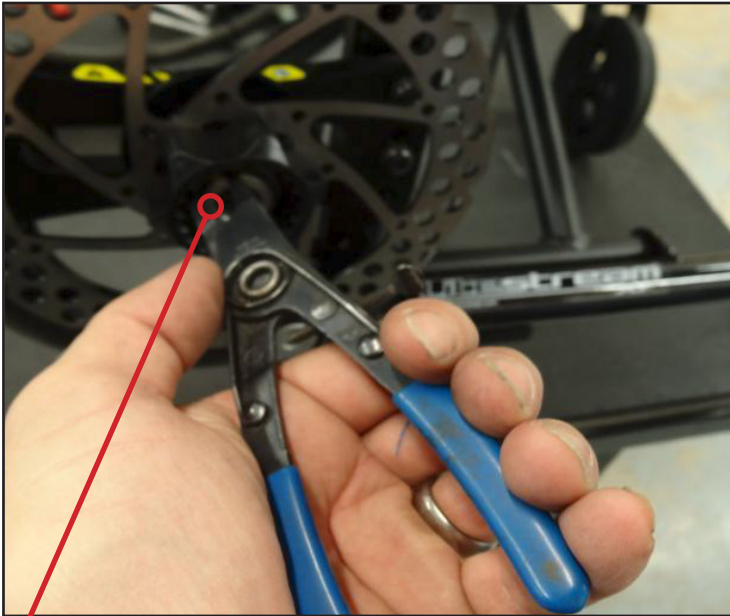

Retaining ring

Step 9: Reattach the calipers to their "U"-shaped brackets by replacing and tightening the removed adjustment bolts. Center the calipers on the rotor discs and tighten the adjustment bolts with a 5mm hex key, taking care not to over-tighten.

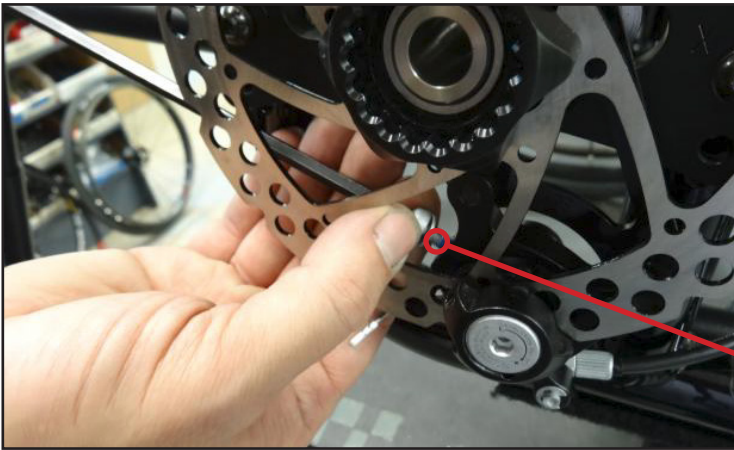

- Further adjustment may be needed. See *Caliper Adjustments* section for instructions.

Adjustment bolt

Lever Kit Installation Instructions

10.5

Each disc brake package will include a brake lever kit specified when the brake package was ordered.

Variable Lever Kit Installation Instructions

10.51

REQUIRED TOOLS:

- Cable cutters
- Zip ties
- Hex keys: 3/32", 1/8", 3/16", 4mm, 5mm

(Note: Perform these steps **after** the disc brake hub assemblies have been installed and adjusted to the wheelchair.)

Step 1: Identify and remove the wheelchair's OEM wheel lock, leaving the existing frame clamp attached.



Step 2: Insert the lever adjustment bar into the existing frame clamp; adjust position as necessary.

- *It is recommended that after the lever is mounted, it should not extend past the chair's frame when engaged fully forward.*

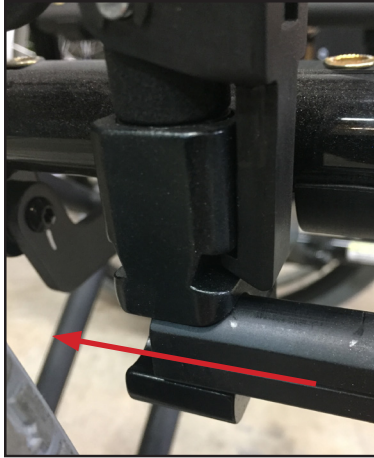

Step 3: When the lever adjustment bar is in the desired position, use a hex key to tighten the screws on the frame clamp.



Step 4: Determine the amount of cable/housing necessary to reach from the upper hole in the lever handle to the cable input ferrules on the *same-side* and *opposite-side* calipers.

- *The cable attaching the lever to the opposite-side caliper should make a gentle “S” shape along the underside of the chair’s seat, allowing some slack for adjustments.*

Step 5: Cut two lengths of cable and housing, ensuring the cuts are clean and free of obstructions.

- *Cut the tubing to the same length. This will provide equal drag and will allow the user to easily switch the side on which the lever is mounted, if necessary. (Note: The Variable Lever comes preassembled for the side specified on the order. To switch sides, it will be necessary to disassemble the lever.*



- *To gauge the necessary length of housing, gently crimp a metal end cap to one end of the housing and insert this crimped end into the adjustable cable input ferrule on the caliper. (Do this with both the same-side and the opposite-side calipers, ensuring equal cable length on both sides.)*

- *Check that the cuts are clean and the cable housing is free of obstructions that can drag on the cable.*
- *If necessary, use zip ties to secure the cables/housing to the chair. The cable/housing attaching the lever to the same-side caliper should meet and run roughly parallel to the cable/housing attaching the lever to the opposite-side caliper.*

Step 6:

- 6a)** Run one end of each cable through the front of the holes in the cable block, pulling the cable until the ends with MTB brads are fully seated in the cable block.



- 6b)** When the cables are fully seated, use a 3/32" hex key to tighten the set screws on the cable block.



Step 7:

- 7a)** Feed the ends of each cable into the housing, leading the cable through the cut ends of the housing first.
- 7b)** Place the housing clamp over the cables and insert the cut ends of the cable housing into the slots on the housing clamp.

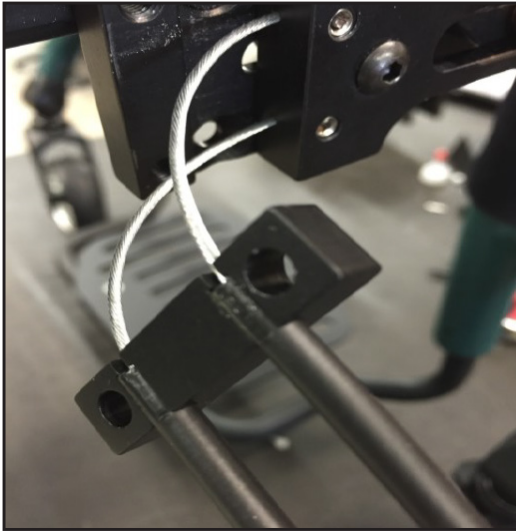

- 7c)** Secure the housing clamp screws with a 3/32" hex key.



Step 8: Feed the cables through the housing and into the cable input ferrules on both calipers.

- *Ensure the lever handle is pulled all the way back in the neutral position.*
- *The ends of the cables should be fully seated in the cable inputs.*

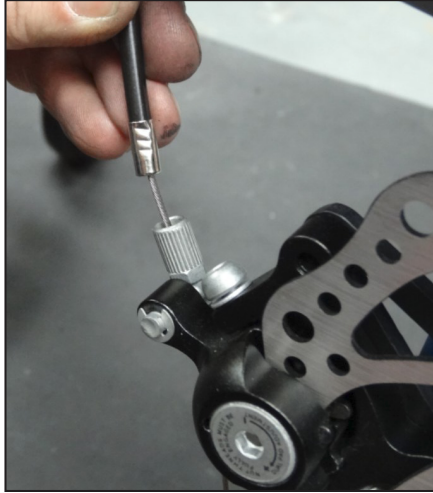

Step 9:

- 9a)** Pull the cable through the input, removing all slack; feed the cable through the clamps on each caliper's moving arm.



- 9b)** Use a 4mm hex key to tighten the caliper clamp screw, locking the cable to the clamps.

Step 10: Using wire cutters, cut away excess cable; cap and crimp the cable ends to prevent cable wear and/or unraveling.



Step 11:

11a) Test the brake system before use, ensuring the system locks and releases fully and easily.

11b) To achieve full and even braking through the entirety of the lever action, first adjust the calipers and brake pads (see *Caliper Adjustments* section of this manual). Minor adjustments to cable tension may be made to equalize tension.

- *The first lever click forward (Click 1) should have slight drag while still allowing the wheels to roll.*
- *The fourth lever click forward (Click 4) should have strong drag while still allowing the wheels to be moved.*
- *Click the lever fully forward (Click 5) should lock both wheels fully.*

Para Lever Kit Installation Instructions

10.52

REQUIRED TOOLS:

- Side cut pliers
- Hex keys: 3/16", 4mm, 5mm
- #2 Phillips screwdriver

(Note: Perform these steps **after** the disc brake hub assemblies have been installed and adjusted to the wheelchair.)

Step 1: Using a #2 Phillips screwdriver, attach the 7/8"-to-3/4" adapter to the lever's clamping section.

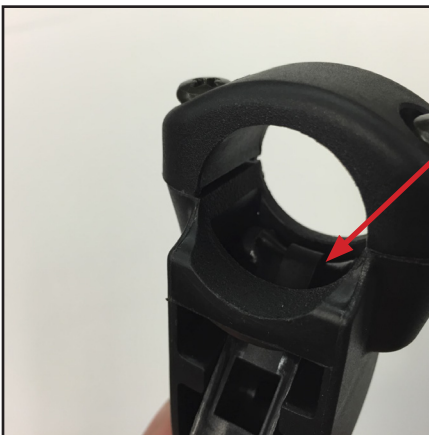
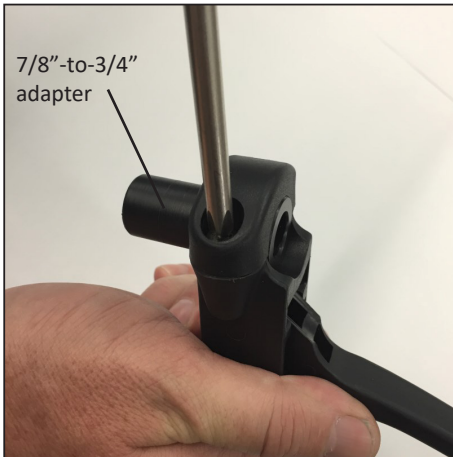

- Ensure the upper pivot point is toward the rear of the mechanism before tightening the top cap.
- Check lever action for smooth operation.

Step 2: Identify and remove the chair's OEM wheel lock, leaving the existing frame clamp attached.



Step 3:

- 3a)** Insert the 7/8" -to-3/4" adapter into the OEM frame clamp; adjust position as necessary.
- 3b)** When the lever is in the desired position, use a hex key to tighten the screws on the frame clamp.



Step 4: Determine the amount of cable/housing necessary to attach the lever to the cable input ferrule on the caliper.

- *The cable attaching the lever to the opposite-side caliper should make a gentle “S” shape along the underside of the chair’s seat, allowing some slack for adjustments.*



- *To gauge the necessary length of housing, gently crimp a metal end cap to one end of the housing and insert this crimped end into the cable input ferrule on the caliper. Then route the housing to the lever input and mark the length to ensure a clean, clear housing cut.*

Step 5: Cut a length of housing, ensuring the cuts are clean and free of obstructions that may drag on the cable.



Step 6: Gently crimp a metal end cap to both ends of the housing.



Step 7: Run one end of the cable through the lower hole in the lever, pulling the cable until the MTB brad fits securely in the recess.



Step 8: Guide the cable through the lever's housing slot.

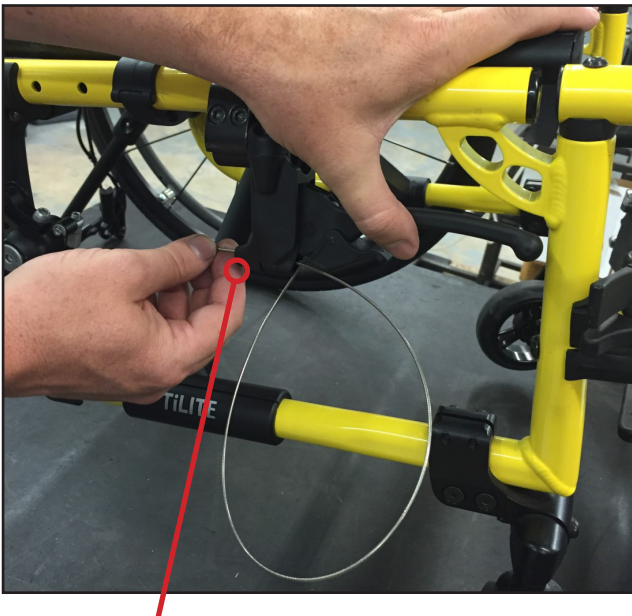

Step 9: Feed the cable through the cable housing, checking for smooth operation.



Step 10: Run the cable through the caliper's cable input ferrule and down through the slot on the caliper's clamping arm, ensuring the cable housing is fully seated in the cable input ferrule.



Step 11: Pull to remove all slack from the cable; tighten clamp screws with a 4mm hex key.

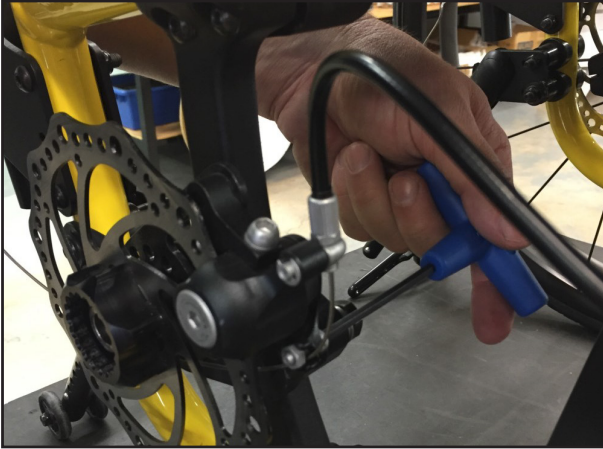

Step 12: Cut away any excess cable, approximately 6" to 1'.



Step 13: Using end caps provided, cap off and crimp the cable ends to prevent wear/unraveling.

- *If necessary, use zip ties to secure the cables/housing to the chair.*

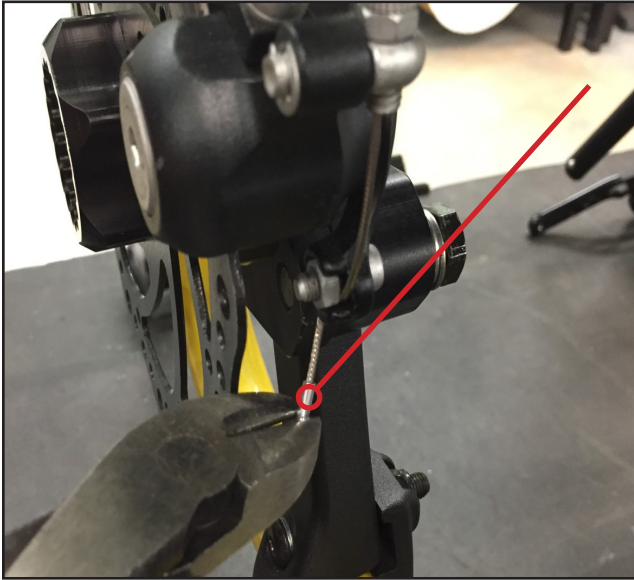

Step 14: Test the brake system before use, ensuring the system locks and releases fully and easily.

Step 15: To achieve full and even braking through the entirety of the lever action, first adjust the calipers and brake pads (see the *Caliper Adjustments* section of this manual). Minor adjustments to cable tension may be made to equalize tension.

Attendant Lever Kit Installation Instructions

10.53

REQUIRED TOOLS:

- Side cut pliers
- Hex keys: 3/16", 4mm, 5mm
- #2 Phillips screwdriver
- Box cutters

(Note: Perform these steps **after** the disc brake hub assemblies have been installed and adjusted to the wheelchair.)

Step 1: Dual-locking attendant levers come in two cane diameters: 7/8" and 1". Ensure you have the correct diameter for your application by measuring the cane diameter at the lever's desired location.



Step 2: Determine the desired mounting locations for the levers. Use box cutters to cut away any obstructive padding or grips and ensure space for the lever handle.



Step 3:

- 3a)** Attach the brake lever clamp on the wheelchair handle.
- 3b)** When the lever is in the desired location, use a #2 Phillips screwdriver to tighten the clamp screws and secure the lever to the handle.

Step 4: Determine the amount of cable/housing necessary to attach the lever to the cable input ferrule on the caliper.

- *Both cables should be of as equal a length as possible to ensure equal cable drag and lever operation.*



- *To gauge the necessary length of housing, gently crimp a metal end cap to one end of the housing and insert this crimped end into the cable input ferrule on the caliper. Then route the housing to the lever input and mark the length to ensure a clean, clear housing cut.*

Step 5: Cut a length of cable housing, ensuring the cuts are clean and free of obstructions that may drag on the cable.



Step 6: Gently crimp a metal end cap to both ends of the cable housing.



Step 7: Run one end of the cable through the lower hole in the lever, pulling the cable until the MTB brad fits securely in the recess.



Step 8: Feed the cable through the housing, checking for smooth operation.



Step 9: Run the cable through the caliper's cable input ferrule and down through the slot on the caliper's clamping arm, ensuring the cable housing is fully seated in the cable input ferrule.

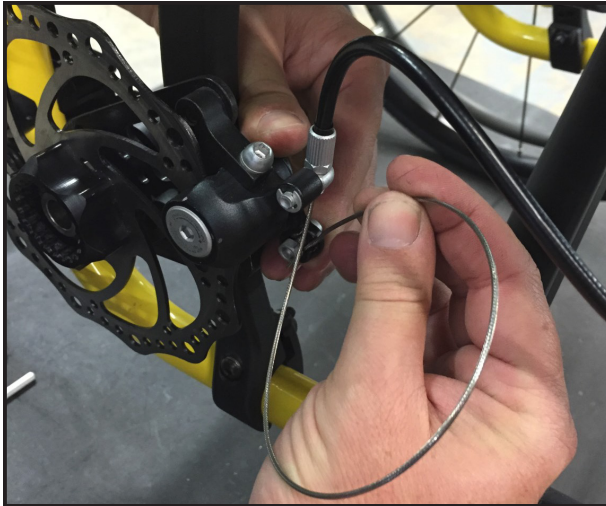
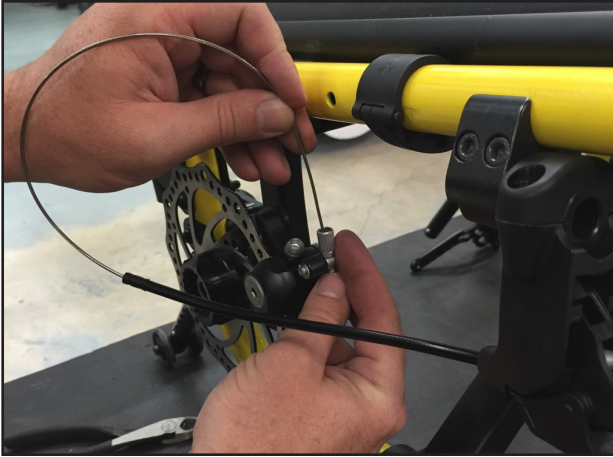

Step 10: Pull to remove all slack from the cable; tighten clamp screws with a 4mm hex key.

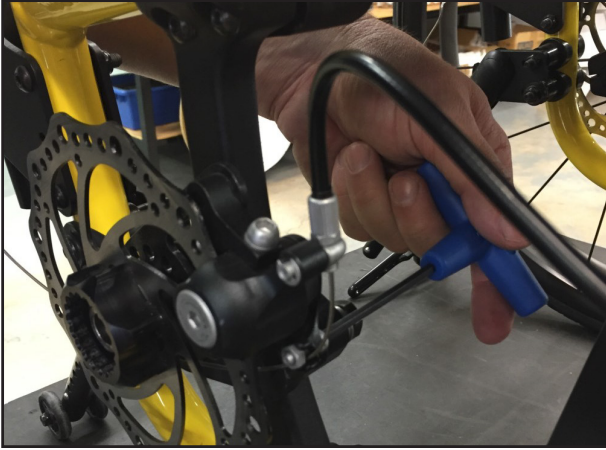

Step 11: Cut away any excess cable, approximately 6" to 1'.



Step 12: Cap and crimp the cable ends to prevent wear/unraveling.

- *If necessary, use zip ties to secure the cables/housing to the chair.*

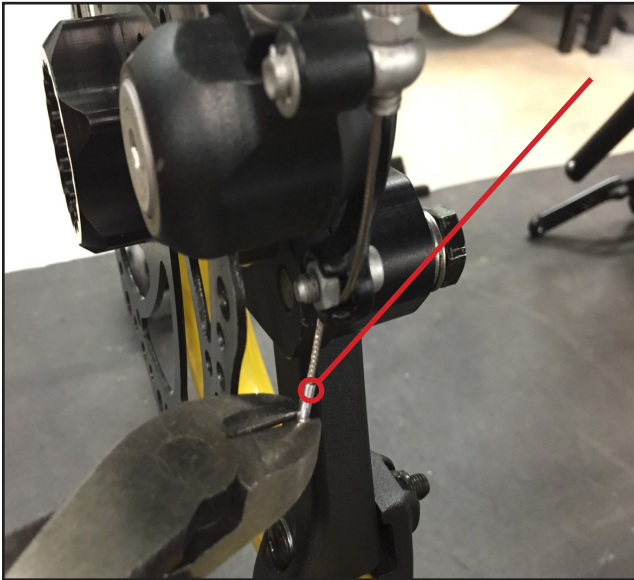

Step 14: Test the brake system before use, ensuring the system locks and releases fully and easily.

Step 15: To achieve full and even braking through the entirety of the lever action, first adjust the calipers and brake pads (see the *Caliper Adjustments* section of this manual). Minor adjustments to cable tension may be made to equalize tension.

Caliper Adjustments

11.0

This section details caliper components, and lists the tools and steps required to adjust them.

CALIPER COMPONENTS AND REQUIRED TOOLS

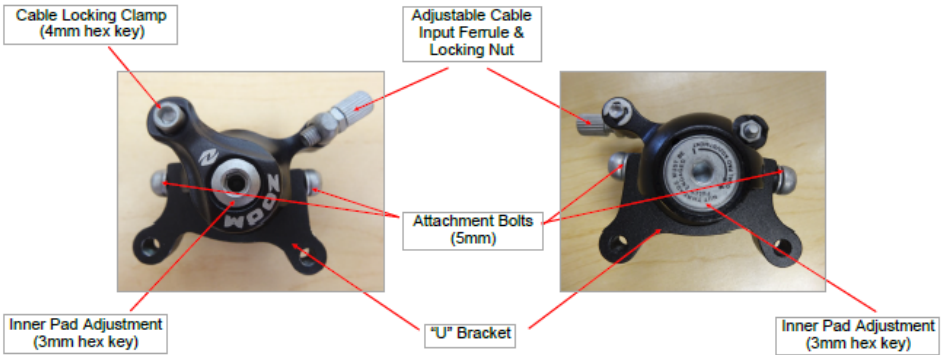
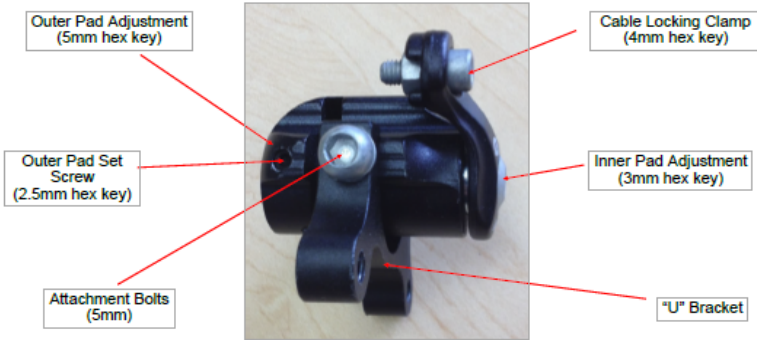

- REQUIRED TOOLS:**
- 8mm open-end wrench
 - Hex keys: 2.5mm, 3mm, 4mm, 5mm
 - Two business cards
 - Snap-ring pliers

Calipers have several points of adjustment:

- Inner Pad Adjustor
- Outer Pad Adjustor
- Attachment Bolts
- Cable Input Ferrule

CALIPER ADJUSTMENT INSTRUCTIONS

Step 1: Begin by checking that the moveable arms on both calipers are at a full open position when the brake is in the neutral position with little to no slack in the cable system.

Step 2: Loosen the attachment bolts with a 5mm hex key. Position the caliper so there is an equal gap between pads on either side of the disc.

Step 3: Attachment bolts also adjust the caliper angle; Ensure the disc is not askew in relation to the pads before tightening the attachment bolts.

Step 4: Loosen the outer pad set screw with a 2.5mm hex key before adjusting the brake pads.

Step 5: Slide one business card on either side of the disc between the pads. Carefully, tighten the inner adjustment and outer adjustment mechanisms a little at a time until the business cards are tight against the disc. Loosen incrementally, just enough to slide the cards out.

Step 6: Engage the brake levers, checking for full wheel braking. The wheels should lock smoothly and easily, without significant force applied to the lever. Make slight adjustments to the outer pad locking screw with a 5mm hex key to achieve these settings.

Step 7: When full braking with minimal lever effort has been achieved, use a 2.5mm hex key to tighten the outer pad locking screw. (**Note:** During this adjustment, the brakes must be fully engaged.)

Step 8: Test the brake system using a series of hard stops and slow braking. Make note of any veering/tracking caused by the brakes. Adjust this tracking by turning the cable input ferrules. When tracking is even, after several tests, tighten the cable input nut with an 8mm hex key.

Dealer Assistance

12.1

During first-time use by the client, it is advised that the dealer or service technician not only assembles the product, but also explains the configuration of user positioning to the customer (the user and/or the attendant). If needed, the dealer can make final adjustments.

User Testing

12.2

It is important that the customer is fully aware of the installation of the disc brake system, how to operate it, and how it can be adjusted according to the needs of the client. A dealer should explain and demonstrate the necessary installation steps, and should explain the functions of the device's components.

Have the user test the position of the brake actuator lever(s).

- Is the hardware in the proper position for the client?
- Can the user safely operate all controls with minimal effort?

If necessary, make adjustments to the positioning. Explain potential problems to the customer and how best to address them.

Conditions of Use

12.3

ADI disc brake systems are intended for use as installed by the dealer, in accordance with the installation instructions in this manual.

- The foreseen conditions of use are communicated by the dealer or service technician to the user and/or attendant during the first-time use.
- If the usage conditions change significantly, please contact your dealer or a qualified service technician to avoid unintended damage.

Cleaning

13.1

Use a soft, damp cloth to clean the hardware and its components. Ensure all cleaners are approved for finished steel and aluminum.

Disinfecting

13.2

Gently wipe the hardware with a soft cloth dampened with a household disinfectant.

General Maintenance

13.3

These care and guideline instructions will keep the hardware in good condition for a longer period of time and will prevent damage:

- Check and re-tighten all fasteners to the proper torque specifications on a regular basis. Reference the installation manual to find proper torque specifications.
- Check components for any breakdown.
- Repair or replace parts as needed.
- Gently remove dust and dirt from hardware with a soft, damp cloth.

SAFETY

Replace or repair parts as needed.

NOTICE

Improper installation or alteration of the hardware included in ADI disc brake systems will void the warranty.



Stealth Products, LLC. • info@stealthproducts.com • www.stealthproducts.com
+1(800) 965-9229 | +1(512) 715-9995 | 104 John Kelly Drive, Burnet TX 78611