



Stealth Products

Tarta® Backs

OWNER'S MANUAL



Tarta® Original

Owner's Manual for the Tarta® Original Backrest System



Stealth Products strives for 100% customer satisfaction. Your complete satisfaction is important. Please contact us with feedback or suggested changes that will help improve the quality and usability of our products. You may reach us at:

Stealth Products, LLC
104 John Kelly Drive, Burnet, TX 78611

Phone: 1 (512) 715-9995	Toll Free: 1 (800) 965-9229
Fax: 1 (512) 715-9954	Toll Free: 1 (800) 806-1225
info@stealthproducts.com	www.stealthproducts.com

General

Read and understand all instructions prior to the use of the product. Failure to adhere to instructions and warnings in this document may result in property damage, injury, or death. Product misuse due to failure to adhere to the following instructions will void the warranty.

Immediately discontinue use if any function is compromised, if parts are missing or loose, or if any component shows signs of excessive wear. Consult your supplier for repairs, adjustments or replacements.

If this document contains information you do not understand, or if there are concerns about safety or operation, contact your supplier.

Important Information!

All persons responsible for fitting, adjustment, and daily use of the devices discussed in these instructions must be familiar with and understand all safety aspects of the devices mentioned. In order for our products to be used successfully, you must:

- Read and understand all instructions and warnings.
- Maintain our products according to our instructions on care and maintenance.
- Ensure devices are installed and adjusted by a trained technician.

Supplier Reference

Supplier:

Telephone:

Address:

Purchase Date:

Model:

Before you install or begin using this product, it is important that you read and understand the content of these installation and operating instructions.

The installation instructions will guide you through the product's options and possibilities.

Instructions are written with the expressed intent of use with standard configurations. They contain important safety and maintenance information, as well as describe possible problems that can arise during use. For further assistance, or for more advanced applications, please contact your supplier or Stealth Products at 1 (512) 715-9995 or toll free at 1 (800) 965-9229.

Always keep the operating instructions in a safe place so they may be referenced as necessary.

All information, pictures, illustrations, and specifications are based on the product information that was available at the time of printing. Pictures and illustrations shown in these instructions are representative examples and are not intended to be exact depictions of the various parts of the product.

Ordering Documentation

You can download additional copies of this user manual by accessing the Stealth website (<https://stlpro.site/stealth-docs>) and searching "*Tarta Original Owners Manual*" in the search bar at the top of the page.

Our products are designed, manufactured, and produced to the highest of standards. If any defect in material or workmanship is found, we will repair or replace the product at our discretion. Any implied warranty, including the implied warranties of merchantability and fitness for a particular purpose, shall not extend beyond the duration of this warranty. Stealth Products, LLC does not warrant damage due to, but not limited to:

- Misuse, abuse, or misapplication of products.
- Modification of product without written approval from Stealth Products, LLC.

Any alteration or lack of serial number, where applicable, will automatically void this warranty.

Stealth Products, LLC is liable for replacement parts only. Stealth Products, LLC is not liable for any incurred labor costs.

No person is authorized to alter, extend, or waive the warranties of Stealth Products, LLC.

Stealth Products, LLC warrants against failure due to defective materials or workmanship:

Covers: 2 years

Hardware: 5 years

Electronics: 3 years

In Case of Product Failure

In the event of product failure covered by our warranty, please follow the procedures outlined below:

1. Call Stealth Products at 1 (512) 715-9995 or toll free 1 (800) 965-9229.
2. Request a Return Authorization form from the Returns Department and follow the documentation instructions.

1.0 Customer Satisfaction	i
2.0 Important Information	ii
3.0 Introduction	iii
4.0 Warranty	iv
5.0 Table of Contents	v
6.0 Warning Labels	vi
6.1 Warning Labels	vi
6.2 Limited Liability	vi
6.3 Testing	vi
7.0 Design and Function	1
7.1 The Tarta Original System	1
7.2 Intended Use.....	1
8.0 Parts and Accessories	2
8.1 Parts Included	2
8.2 Tarta Original Back Specifications	3
8.3 Rib Selection	21
8.4 Pad Selection	22
8.5 Mounting Hardware Options	23
9.0 First-Time Use	25
9.1 Dealer Assistance.....	25
9.2 User Testing.....	25
9.3 Conditions of Use	25
10.0 Maintenance	26
10.1 Cleaning	26
10.2 Maintenance	26

Warning Labels

6.1

Warnings are included for the safety of the user, client, operator and property. Please read and understand what the signal words **DANGER, WARNING, CAUTION, NOTICE,** and **SAFETY** mean, and how they could affect the user, those around the user, and property.

DANGER

Identifies an **imminent** situation which, if not avoided, may result in **severe injury, death,** and **property damage.**

WARNING

Identifies a **potential** situation which, if not avoided, may result in **severe injury, death,** and **property damage.**

CAUTION

Identifies a **potential** situation which, if not avoided, may result in **minor to moderate injury** and **property damage.**

NOTICE

Identifies important information not related to injury, but possible **property damage.**

SAFETY

Indicates steps or instructions for safe practices, reminders of safe procedures, or important safety equipment that may be necessary.

Limited Liability

6.2

Stealth Products, LLC accepts no liability for personal injury or damage to property that may arise from the failure of the user or other persons to follow the recommendations, warnings, and instructions in this manual.

Stealth Products, LLC does not hold responsibility for final integration of final product assembly to the end user. Stealth Products, LLC is not liable for user injury or death.

Testing

6.3

Initial setup and test driving should be done in an open area free of obstacles until the user is fully capable of operating safely.

The **Tarta Original** back should always be tested without any person sitting in the wheelchair until every alteration of the physical installation or adjustment is complete.

The Tarta System

7.1

The **Tarta Original** system is a backrest devised to be adaptable to each individual and his/her unique positioning needs. It utilizes a combination of design, materials, and technology to deliver a highly configurable, easy-to-use product. **Tarta Original** offers a high degree of comfort while introducing a uniquely functional design following the modular build-a-back philosophy.

The materials used in **Tarta Original** have been designed to achieve the highest levels of performance. The pre-stressed steel used for the vertical spine column flexes to follow the movement of the person, giving freedom of movement, and then returns to its original position. The padding is made of washable, breathable material.

The **Tarta Original** backrest consists of an exoskeleton similar to the rib cage in which adjustable aluminum ribs can be configured to conform to the position of the person, and are attached to customizable central vertebrae which simulate a spinal column.

Intended Use

7.2

The **Tarta Original** system's balance of comfort and functionality provides unique supportive benefits to users with even the most difficult postural abnormalities. Its versatility and adaptability allow for a custom-molded fit for each patient, while its individually and independently mounted staves allow the **Tarta Original** backrest to be fully customizable.

The **Tarta Original** system is intended for use by individuals for whom other seating systems lack the necessary support and customizability, as well as for individuals who, clinically, have non-traditional sizing requisites.

Parts Included

8.1

The **Tarta Original** system consists of a series of vertebrae that, when joined together by elements made of pre-stressed steel, reproduce the shape and characteristics of a spinal column.

The following items are included with each **Tarta** system:

Vertebrae

Each column is made up of a series of vertebrae, from size ranges of four to six vertebrae, but the custom build-a-back nature of the product allows for virtually any height back configuration.

Each vertebra has a height of 50mm (1.97in) and a digression to 10mm (.39in).

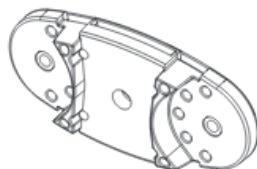

Ribs

On each vertebra it is possible to fit ribs that provide both posterior and lateral support. These ribs are available in four different sizes: small, medium, large, and extra large. Made of malleable aluminum, they can be manually contoured in the field to create a more intimate fit.

Each rib can also be adjusted by moving the locking plug in order to find the exact position necessary.



Padding

Once installed, the padding is fitted and easily adjusted by means of the hook-and-loop fasteners.



Hardware

Once the final configuration has been established, the pads can be permanently mounted to the ribs using the provided t-nuts.

Tarta Original Back Specifications

8.4

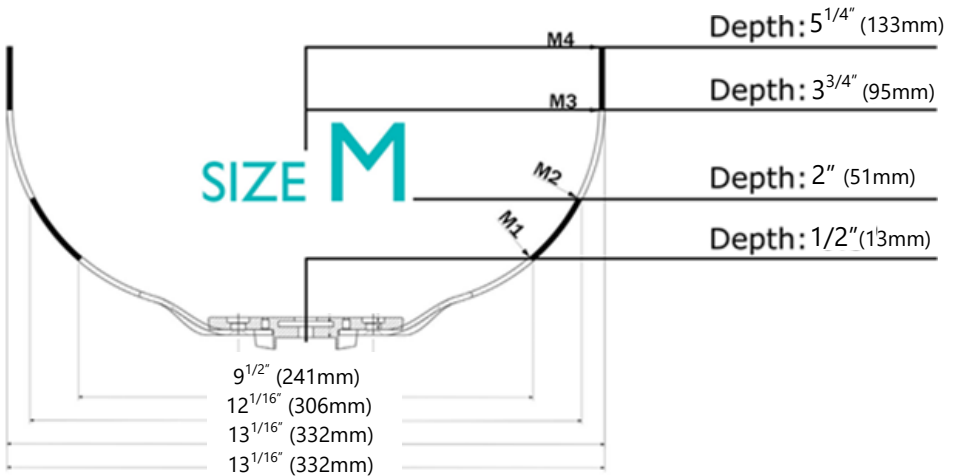
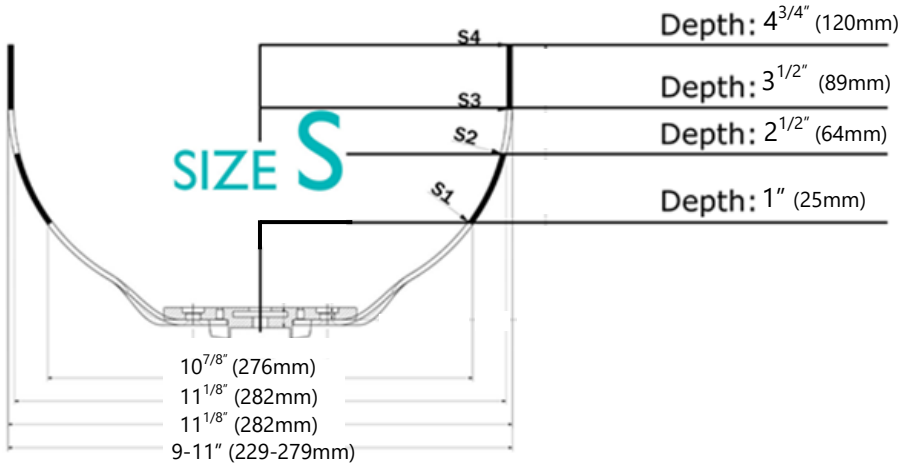

NOTICE All measurements are approximate.

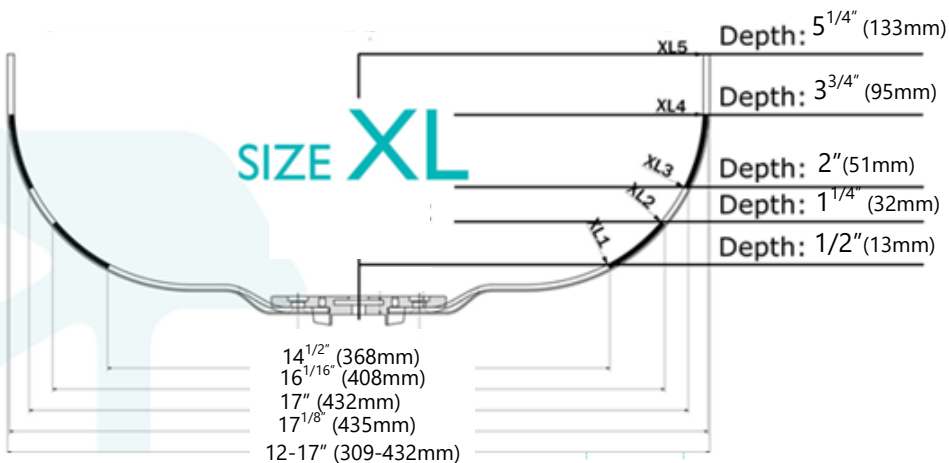
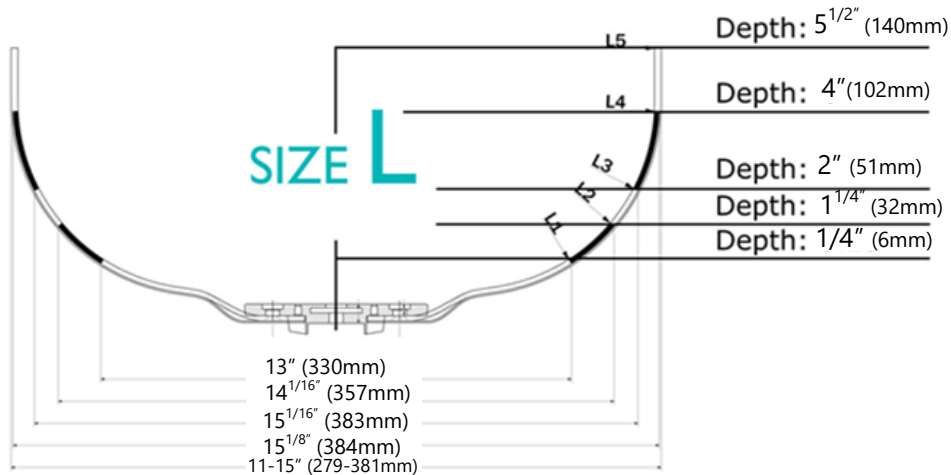









TRTBS4A Tarta Package





Height Range

8" - 9"

Trunk Width Range

<10"

Ribs Sequence (Right)		Spine	Ribs Sequence (Left)	
A	 TRT-RIB-S1		TRT-RIB-S1	A 
B	 TRT-RIB-S2		TRT-RIB-S2	B 
C	 TRT-RIB-S2		TRT-RIB-S2	C 
D	 TRT-RIB-S1		TRT-RIB-S1	D 

Lateral Pads (Right)	Central Pads	Lateral Pads (Left)
TRT-PAD-056 	TRT-PAD-062 	TRT-PAD-056 
TRT-PAD-059 		TRT-PAD-051 

The following ribs and pads are also included in the package to transform a standard active back configuration into a **DEEP** contour back:







To create a deep contour on your **Tarta Original** back:







- Remove the first set of -S2 ribs (B) and replace with the -S4 ribs.
- Remove the -056 pads and replace with the -053 pads.
- Two extra -S3 ribs and two extra -051 pads are provided for the user.

TRTBM4A Tarta Package

Height Range
8" - 9"

Trunk Width Range
10" - 12"

Ribs Sequence (Right)		Spine	Ribs Sequence (Left)	
A	 TRT-RIB-M1		TRT-RIB-M1	A
B	 TRT-RIB-M2		TRT-RIB-M2	B
C	 TRT-RIB-M3		TRT-RIB-M3	C
D	 TRT-RIB-M2		TRT-RIB-M2	D

Lateral Pads (Right)	Central Pads	Lateral Pads (Left)
TRT-PAD-056 	TRT-PAD-062 	TRT-PAD-056 
TRT-PAD-060 	TRT-PAD-051 	TRT-PAD-060 

The following ribs and pads are also included in the package to transform a standard active back configuration into a **DEEP** contour back:



To create a deep contour on your **Tarta Original** back:

- Remove the -M1 (A) and first set of -M2 ribs (B). Shift the -M2 ribs up (spot A) and in place of the -M1 ribs.
- Attach the -M4 ribs in place of -M2 ribs (spot B).
- Remove the -056 pads and replace with -054 pads.
- Two extra -051 pads are provided for the user.









TRTBL4A Tarta Package







Height Range

8" - 9"

Trunk Width Range

12" - 14"

Ribs Sequence (Right)		Spine	Ribs Sequence (Left)	
A	 TRT-RIB-L1		TRT-RIB-L1	 A
B	 TRT-RIB-L3		TRT-RIB-L3	 B
C	 TRT-RIB-L3		TRT-RIB-L3	 C
D	 TRT-RIB-L2		TRT-RIB-L2	 D

Lateral Pads (Right)	Central Pads	Lateral Pads (Left)
TRT-PAD-057 	TRT-PAD-062 	TRT-PAD-057 
TRT-PAD-060 	TRT-PAD-051 	TRT-PAD-060 

The following ribs and pads are also included in the package to transform a standard active back configuration into a **DEEP** contour back:

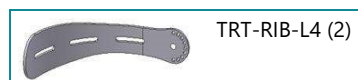

To create a deep contour on your **Tarta Original** back:

- Remove the first set of -L3 ribs (B) and replace with the -L4 ribs.
- Remove the -057 pads and replace with the -054 pads.
- Two extra -L5 ribs and -051 pads are provided for the user.









TRTBX4A Tarta Package





Height Range

8" - 9"

Trunk Width Range

14" - 17"

Ribs Sequence (Right)		Spine	Ribs Sequence (Left)	
A	 TRT-RIB-XL1		TRT-RIB-XL1	A 
B	 TRT-RIB-XL3		TRT-RIB-XL3	B 
C	 TRT-RIB-XL3		TRT-RIB-XL3	C 
D	 TRT-RIB-XL2		TRT-RIB-XL2	D 

Lateral Pads (Right)	Central Pads	Lateral Pads (Left)
TRT-PAD-058 	TRT-PAD-062 	TRT-PAD-058 
TRT-PAD-060 		TRT-PAD-051 

The following ribs and pads are also included in the package to transform a standard active back configuration into a **DEEP** contour back:

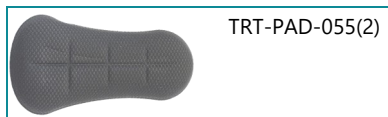

To create a deep contour on your **Tarta Original** back:

- Remove the first set of -XL3 ribs (B) and replace with the -XL4 ribs.
- Remove the -058 pads and replace with the -055 pads.
- Two extra -XL5 ribs and -051 pads are provided for the user.















TRTBS5A Tarta Package









Height Range

10" - 11"

Trunk Width Range

<10"

Ribs Sequence (Right)	Spine	Ribs Sequence (Left)
A  TRT-RIB-S1		TRT-RIB-S1  A
B  TRT-RIB-S2		TRT-RIB-S2  B
C  TRT-RIB-S2		TRT-RIB-S2  C
D  TRT-RIB-S2		TRT-RIB-S2  D
E  TRT-RIB-S1		TRT-RIB-S1  E

Lateral Pads (Right)	Central Pads	Lateral Pads (Left)
TRT-PAD-056 	TRT-PAD-062 	TRT-PAD-056 
TRT-PAD-051 	TRT-PAD-052 	TRT-PAD-051 
TRT-PAD-059 		TRT-PAD-059 

The following ribs and pads are also included in the package to transform a standard active back configuration into a **DEEP** contour back:



To create a deep contour on your **Tarta Original** back:

- Remove the first set of -S2 ribs (B) and replace with the -S4 ribs.
- Remove the -056 pads and replace with the -053 pads.
- Two extra -S3 ribs are provided for the user.









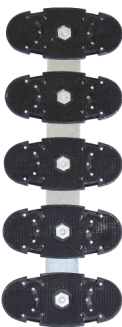

TRTBM5A Tarta Package









Height Range

10" - 11"

Trunk Width Range

10" - 12"

Ribs Sequence (Right)	Spine	Ribs Sequence (Left)
A  TRT-RIB-M1		TRT-RIB-M1  A
B  TRT-RIB-M2		TRT-RIB-M2  B
C  TRT-RIB-M2		TRT-RIB-M2  C
D  TRT-RIB-M3		TRT-RIB-M3  D
E  TRT-RIB-M2		TRT-RIB-M2  E

Lateral Pads (Right)	Central Pads	Lateral Pads (Left)
TRT-PAD-056 	TRT-PAD-062 	TRT-PAD-056 
TRT-PAD-051 		TRT-PAD-051 
TRT-PAD-060 	TRT-PAD-052 	TRT-PAD-060 

The following ribs and pads are also included in the package to transform a standard active back configuration into a **DEEP** contour back:



To create a deep contour on your **Tarta Original** back:

- Remove the first set of -M2 ribs (B) and replace with the -M4 ribs.
- Remove the -056 pads and replace with the -054 pads.

TRTBL5A Tarta Package









Height Range

10" - 11"

Trunk Width Range

12" - 14"

Ribs Sequence (Right)		Spine	Ribs Sequence (Left)	
A	 TRT-RIB-L2		TRT-RIB-L2	A 
B	 TRT-RIB-L3		TRT-RIB-L3	B 
C	 TRT-RIB-L2		TRT-RIB-L2	C 
D	 TRT-RIB-L3		TRT-RIB-L3	D 
E	 TRT-RIB-L2		TRT-RIB-L2	E 

Lateral Pads (Right)	Central Pads	Lateral Pads (Left)
TRT-PAD-057 	TRT-PAD-062 	TRT-PAD-057 
TRT-PAD-051 	TRT-PAD-052 	TRT-PAD-051 
TRT-PAD-060 		TRT-PAD-060 

The following ribs and pads are also included in the package to transform a standard active back configuration into a **DEEP** contour back:



To create a deep contour on your **Tarta Original** back:

- Remove the first set of -L3 ribs (B) and replace with the -L5 ribs.
- Remove the second set of -L3 ribs (D) and replace with the -L4 ribs.
- Remove the bottom set of -L2 ribs (E) and replace with the -L3 ribs.
- Remove the -057 pads and replace with the -054 pads.









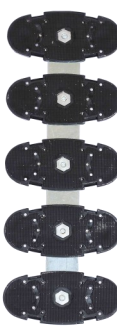

TRTBX5A Tarta Package









Height Range

10" - 11"

Trunk Width Range

14" - 17"

Ribs Sequence (Right)	Spine	Ribs Sequence (Left)
A  TRT-RIB-XL1		TRT-RIB-XL1  A
B  TRT-RIB-XL3		TRT-RIB-XL3  B
C  TRT-RIB-XL2		TRT-RIB-XL2  C
D  TRT-RIB-XL3		TRT-RIB-XL3  D
E  TRT-RIB-XL2		TRT-RIB-XL2  E

Lateral Pads (Right)	Central Pads	Lateral Pads (Left)
TRT-PAD-058 	TRT-PAD-062 	TRT-PAD-058 
TRT-PAD-051 		TRT-PAD-051 
TRT-PAD-060 	TRT-PAD-052 	TRT-PAD-060 

The following ribs and pads are also included in the package to transform a standard active back configuration into a **DEEP** contour back:



To create a deep contour on your **Tarta Original** back:

- Remove the first set of -XL3 ribs (B) and replace with the -XL5 ribs.
- Remove the bottom set of -XL3 ribs (D) and replace with the -XL4 ribs.
- Remove the -058 pads and replace with the -055 pads.
- Remove the -060 pads and replace with the -061 pads.

TRTBS6A Tarta Package









Height Range

12"

Trunk Width Range

<10"

Ribs Sequence (Right)	Spine	Ribs Sequence (Left)
A  TRT-RIB-S1		TRT-RIB-S1  A
B  TRT-RIB-S2		TRT-RIB-S2  B
C  TRT-RIB-S2		TRT-RIB-S2  C
D  TRT-RIB-S1		TRT-RIB-S1  D
E  TRT-RIB-S2		TRT-RIB-S2  E
F  TRT-RIB-S1		TRT-RIB-S1  F

Lateral Pads (Right)	Central Pads	Lateral Pads (Left)
G  TRT-PAD-056	 TRT-PAD-062	TRT-PAD-056  G
H  TRT-PAD-056	 TRT-PAD-052	TRT-PAD-056  H
I  TRT-PAD-059	 TRT-PAD-051	TRT-PAD-059  I

The following ribs and pads are also included in the package to transform a standard active back configuration into a **DEEP** contour back:



To create a deep contour on your **Tarta Original** back:









- Remove the first set of -S2 ribs (B) and replace with the -S4 ribs.
- Remove the bottom set of -S2 ribs (E) and replace with the -S3 ribs.
- Remove the bottom set of -S1 ribs (F) and replace with the -S2 ribs.
- Remove the first set of -056 pads (G) and replace with -053 pads.
- Two extra -051 pads are provided for the user.

TRTBM6A Tarta Package

Height Range
12" - 13"

Trunk Width Range
10" - 12"

Ribs Sequence (Right)		Spine	Ribs Sequence (Left)	
A	 TRT-RIB-M1		TRT-RIB-M1	 A
B	 TRT-RIB-M2		TRT-RIB-M2	 B
C	 TRT-RIB-M2		TRT-RIB-M2	 C
D	 TRT-RIB-M1		TRT-RIB-M1	 D
E	 TRT-RIB-M3		TRT-RIB-M3	 E
F	 TRT-RIB-M2		TRT-RIB-M2	 F

Lateral Pads (Right)	Central Pads	Lateral Pads (Left)
G TRT-PAD-056 	TRT-PAD-062 	TRT-PAD-056  G
H TRT-PAD-056 	TRT-PAD-052 	TRT-PAD-056  H
I TRT-PAD-060 	TRT-PAD-051 	TRT-PAD-060  I

The following ribs and pads are also included in the package to transform a standard active back configuration into a **DEEP** contour back:



To create a deep contour on a **Tarta Original** back:









- Remove the first set of -M2 ribs (B) and replace with the -M4 ribs.
- Remove the second set of -M1 ribs (D) and replace with the -M3 ribs.
- Remove the first set of -056 pads (G) and replace with the -054 pads.
- Remove the bottom set of -056 pads (H) and replace with the -057 pads.
- Two extra -051 pads are provided for the user.

TRTBL6A Tarta Package

Height Range
13"

Trunk Width Range
12" - 14"

Ribs Sequence (Right)	Spine	Ribs Sequence (Left)
A  TRT-RIB-L2		TRT-RIB-L2  A
B  TRT-RIB-L3		TRT-RIB-L3  B
C  TRT-RIB-L2		TRT-RIB-L2  C
D  TRT-RIB-L3		TRT-RIB-L3  D
E  TRT-RIB-L3		TRT-RIB-L3  E
F  TRT-RIB-L2		TRT-RIB-L2  F

Lateral Pads (Right)	Central Pads	Lateral Pads (Left)
G  TRT-PAD-057	TRT-PAD-062 	TRT-PAD-057  G
H  TRT-PAD-057	TRT-PAD-052 	TRT-PAD-057  H
I  TRT-PAD-060	TRT-PAD-051 	TRT-PAD-060  I

The following ribs and pads are also included in the package to transform a standard active back configuration into a **DEEP** contour back:

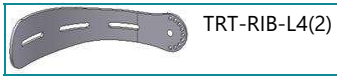

To create a deep contour on a **Tarta Original** back:

- Remove the first set of -L3 ribs (B) and replace with the -L5 ribs.
- Remove the last set of -L3 ribs (E) and replace with the -L4 ribs.
- Remove the bottom set of -L2 ribs (F) and replace with the -L3 ribs.
- Remove the first set of -057 pads (G) and replace with the -054 pads.
- Two extra -051 pads are provided for the user.

TRTBX6A Tarta Package









Height Range

14"

Trunk Width Range

14" - 17"

Ribs Sequence (Right)		Spine	Ribs Sequence (Left)	
A	 TRT-RIB-XL1		TRT-RIB-XL1	A 
B	 TRT-RIB-XL3		TRT-RIB-XL3	B 
C	 TRT-RIB-XL2		TRT-RIB-XL2	C 
D	 TRT-RIB-XL1		TRT-RIB-XL1	D 
E	 TRT-RIB-XL3		TRT-RIB-XL3	E 
F	 TRT-RIB-XL2		TRT-RIB-XL2	F 

Lateral Pads (Right)		Central Pads	Lateral Pads (Left)	
G	TRT-PAD-058 	TRT-PAD-062 	TRT-PAD-058	G 
H	TRT-PAD-057 	TRT-PAD-052 	TRT-PAD-057	H 
I	TRT-PAD-060 	TRT-PAD-051 	TRT-PAD-060	I 

The following ribs and pads are also included in the package to transform a standard active back configuration into a **DEEP** contour back:





To create a deep contour on a **Tarta Original** back:





- Remove the first set of -XL3 ribs (B) and replace with the -XL5 ribs.
- Remove the second set of -XL1 ribs (D) and replace with the -XL3 ribs.
- Remove the second set of -XL3 ribs (E) and replace with the -XL4 ribs.
- Remove the -058 pads (G) and replace with the -055 pads.
- Remove the -057 pads (H) and replace with the -058 pads.
- Remove the -060 pads (I) and replace with the -061 pads.





Rib Selection





8.3

The charts below list the ribs available to create a custom **Tarta Original** back:

Rib Size	Product	Part Number
S		TRT-RIB-S1
S		TRT-RIB-S2
S		TRT-RIB-S3
S		TRT-RIB-S4

Rib Size	Product	Part Number
M		TRT-RIB-M1
M		TRT-RIB-M2
M		TRT-RIB-M3
M		TRT-RIB-M4













Rib Size	Product	Part Number
L		TRT-RIB-L1
L		TRT-RIB-L2
L		TRT-RIB-L3
L		TRT-RIB-L4
L		TRT-RIB-L5

Rib Size	Product	Part Number
XL		TRT-RIB-XL1
XL		TRT-RIB-XL2
XL		TRT-RIB-XL3
XL		TRT-RIB-XL4
XL		TRT-RIB-XL5

Pad Selection

8.4

12 pads of different sizes are available to create a custom **Tarta Original** back:

Product	Part Number	Product	Part Number
 $4\frac{3}{8}'' \times 2\frac{1}{16}''$	TRT-PAD-051	 $6\frac{1}{8}'' \times 4\frac{3}{8}''$	TRT-PAD-057
 $4\frac{3}{8}'' \times 4\frac{1}{2}''$	TRT-PAD-052	 $7'' \times 4\frac{1}{2}''$	TRT-PAD-058
 $7\frac{1}{16}'' \times 4\frac{7}{8}''$	TRT-PAD-053	 $5\frac{1}{16}'' \times 4\frac{7}{8}''$	TRT-PAD-059
 $8\frac{1}{4}'' \times 4\frac{7}{8}''$	TRT-PAD-054	 $6\frac{3}{4}'' \times 5''$	TRT-PAD-060
 $9\frac{1}{2}'' \times 4\frac{7}{8}''$	TRT-PAD-055	 $4\frac{1}{2}'' \times 5\frac{1}{8}''$	TRT-PAD-061
 $5\frac{3}{8}'' \times 4\frac{1}{8}''$	TRT-PAD-056	 $4\frac{1}{2}'' \times 7\frac{5}{8}''$	TRT-PAD-062

Mounting Hardware Options

8.7



Description	Part Number	12	13	14	15	16	17	18	19	20
Tarta Hardware Kit, Single Point, Adjustable Height, Small-Medium	TRTHW1AS	X	X	X	X	X				
Tarta Hardware Kit, Single Point, Adjustable Height, Large-X Large	TRTHW1AL						X	X	X	X



Description	Part Number	12	13	14	15	16	17	18	19	20
Tarta Hardware Kit, Single Point, Fixed, Small-Medium	TRTHW1FS	X	X	X	X	X				
Tarta Hardware Kit, Single Point, Fixed, Large- X Large	TRTHW1FL						X	X	X	X



Description	Part Number	12	13	14	15	16	17	18	19	20
Tarta Hardware Kit, 2 Point, Removable, Small-Medium	TRTHW2RS		X	X	X					
Tarta Hardware Kit, 2 Point, Removable, Large-X Large	TRTHW2RL					X	X	X	X	X



Description	Part Number	12	13	14	15	16	17	18	19	20
Tarta Hardware Kit, Single Point, Removable, Small-Medium	TRTHW1RS			X	X					
Tarta Hardware Kit, Single Point, Removable, Large-X Large	TRTHW1RL					X	X	X		

Dealer Assistance

9.1

During first-time use by the client, it is advised that the dealer or service technician not only assemble the device, but explains the different configurations to the client as well. If needed, the dealer can make final adjustments.

User Testing

9.2

It is important that the customer is fully aware of the installation and how to adjust the position of the ribs and vertebrae in order to have the **Tarta Original** back in the best position for the user.

Have the user test the position of the back:

- Is the placement of the **Tarta Original** back in an optimal position for the user?
- Can the user safely operate chair with the placement of the back?

If needed, adjust the **Tarta Original** back to the best position for the user.

Explain to the client the possible problems that could arise with the hardware and how to address them.

Conditions of Use

9.3

The **Tarta Original** back is intended for use as installed by the dealer, in accordance to the installation and instructions in this manual.

- Ensure the foreseen conditions of use are communicated by the dealer or service technician to the user and/or attendant during the first-time use.
- If the usage conditions change significantly, please contact your dealer or a qualified service technician to avoid excessive wear and tear or unintended damage.

DANGER

Failure to comply with these warnings could result in serious bodily harm.

Cleaning

10.1

- The individual parts of the device can be cleaned with a soft, damp cloth.
- Do not immerse the device in water.
- The pads are machine washable. Do not wash with water warmer than 86°F (30°C).
- Dry with a soft, clean cloth.

SAFETY

The **Tarta Original** back should never come into direct contact with the client's skin. A garment or protective material should be worn to avoid skin irritation.

Maintenance

10.2

- Avoid direct contact with fire. Flames could damage the device and cause injury to the user.
- Do not leave the backrest inside the car when exposed to the sun. Excessive temperatures can damage the adhesive applied on the hook-and-loop strap slats.
- Avoid contact with sharp and/or pointed objects or instruments that might damage the device and/or the padding.

SAFETY

Periodically check that the mechanical parts that make up the device have not become loose or misaligned.



Stealth Products, LLC. • info@stealthproducts.com • www.stealthproducts.com
+1(800) 965-9229 | +1(512) 715-9995 | 104 John Kelly Drive, Burnet TX 78611