

Custom Seat Cushion Order Form

This order form uses Adobe Acrobat® interactive technology and we recommended you to use Acrobat Reader DC or later after downloading and saving the form to your local drive.

[E2609] Unless otherwise noted, US Only. HCPCS codes provided should not be considered as legal advice and do not guarantee reimbursement.

+1 (512) 715-9995
+1 (800) 965-9229 Toll Free
+1 (512) 715-9954 Fax
+1 (800) 806-1225 Toll Free Fax

104 John Kelly Drive,
Burnet, TX 78611
information@sw.stealthproducts.com
www.stealthproducts.com
facebook.com/StealthProducts
twitter.com/stealthproducts

PO#:

Client:

Branch: **Date:**

Contact:

E-mail:

Phone: **Fax:**

Mark for: Order Type: Quote Order

Fields or sections with asterisk (*) are required.

Mobility Base Information

Manufacturer:

Model:

Serial:

Frame Color:

Frame Width:

Frame Depth:

Tubing: 7/8in (2.22cm) 1in (2.54 cm)

Client Seat Area Measurements

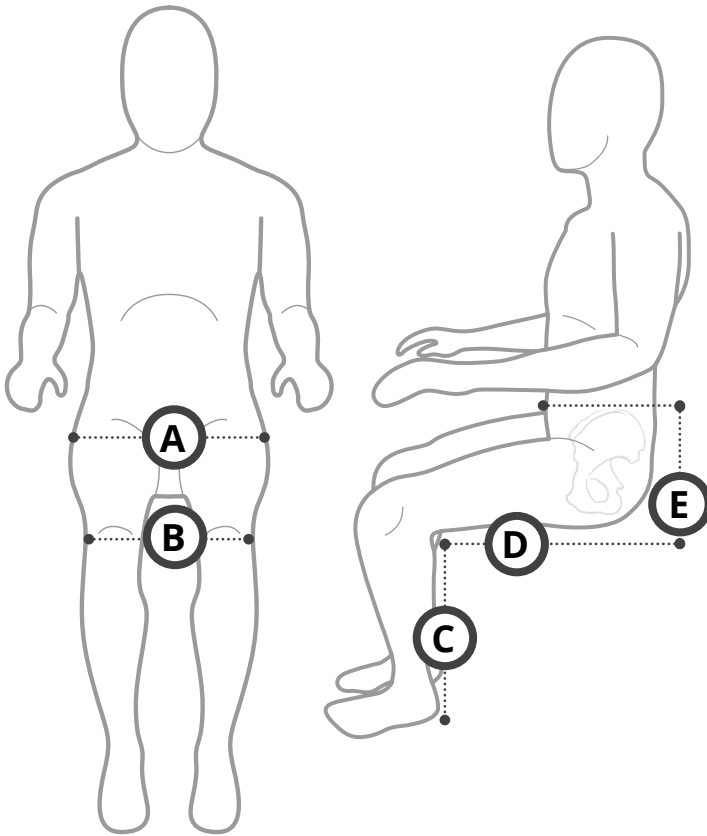

A. Seat Width: _____ **C. Seat to Footplate:** _____

B. Knee Adduction: _____ **D. Total Seat Depth:** _____

E. Seat to PSIS: _____

Seat Cushion Expected Overall Dimension

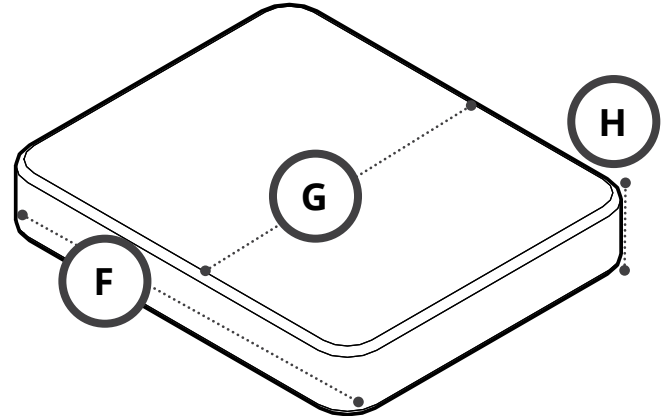

F. Overall Depth*: _____

G. Overall Width*: _____

H. Overall Height*: _____

Internal Use Only

For CSRs use only. Summary of selections will show up here to confirm accuracy of configuration.

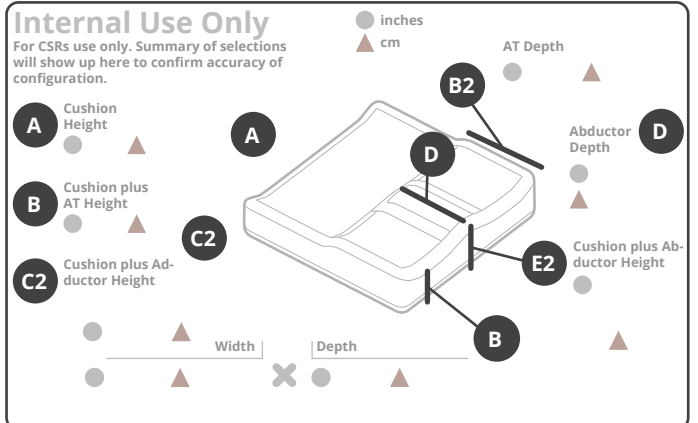

Fields or sections with asterisk (*) are required

1 Cushion Size

SEAT CUSHION SIZING*

\$607.70

Width	10in	12in	14in	16in	18in	20in	22in	24in
	(25.40cm)	(30.48cm)	(35.56cm)	(40.64cm)	(45.72cm)	(50.80cm)	(55.88cm)	(60.96cm)
Depth	10in	<input type="checkbox"/> SMD1010	<input type="checkbox"/> SMD1210					
	12in	<input type="checkbox"/> SMD1012	<input type="checkbox"/> SMD1212	<input type="checkbox"/> SMD1412				
	14in	<input type="checkbox"/> SMD1014	<input type="checkbox"/> SMD1214	<input type="checkbox"/> SMD1414	<input type="checkbox"/> SMD1614			
	16in		<input type="checkbox"/> SMD1216	<input type="checkbox"/> SMD1416	<input type="checkbox"/> SMD1616	<input type="checkbox"/> SMD1816		
	18in			<input type="checkbox"/> SMD1418	<input type="checkbox"/> SMD1618	<input type="checkbox"/> SMD1818	<input type="checkbox"/> SMD2018	
	20in				<input type="checkbox"/> SMD1620	<input type="checkbox"/> SMD1820	<input type="checkbox"/> SMD2020	<input type="checkbox"/> SMD2220
	22in				<input type="checkbox"/> SMD1822	<input type="checkbox"/> SMD2022	<input type="checkbox"/> SMD2222	<input type="checkbox"/> SMD2422
	24in					<input type="checkbox"/> SMD2024	<input type="checkbox"/> SMD2224	<input type="checkbox"/> SMD2424

\$491.31

\$566.50

CLIENT SPECIFIED SIZING

The seat cushion will require extended lead time and a 60% upcharge if its sizing falls outside the above matrix. Set sizes by 1in (2.54cm) increments.

SMDCSHSP0 Specified Dimensions Seat Base: **Width:..... X Depth:**

5/8in (1.59cm) Cross Link **Foundation** **Note:** This cover included with the cushion supports up to 4.5in (11.43cm) of Foam Thickness, any thickness beyond that will require to contact directly Stealth Representative or CSR for extended lead time. *** Contour Format requires Cross Link Foundation Foam. If OC3 is selected, add "-OC3" at the end of the Seat Cushion Sizing part number.
1/2in (1.27cm) OC3 **Foam*****

Integrated Seat Pan

Note: Does not include foundation foam. Must select integrated seat pan cover.

12x14 and below\$126 **12x16 to 20x22.....\$178** **20x24 and up \$243**
 Part: SEATPANXXYY-INT Part: SEATPANXXYY-INT Part: SEATPANXXYY-INT

COVER CONTACT MATERIAL*

The XXYY portion of all part numbers on this page directly relate to the dimensions of the cushion, where XX represents the width and YY represents the depth. For example, a 10" wide by 10" deep cushion with CoolCore Cover would be SMDCOV1010C.

CoolCore® Cover

CoolCore® Cover \$0
 Part: SMDCOVXXYYC
CoolCore® Cover for Integrated seat pan; up to 20x24..... \$51.50
 Must select integrated seat pan option above.
 Part: SMDCOVXXYYC
CoolCore® Cover for Integrated seat pan; 22x20 and up \$74.40
 Must select integrated seat pan option above.
 Part: SMDCOVXXYYC

Air Flow Mesh Cover

Air Flow Mesh Cover \$0
 Part: SMDCOVXXYYM
Air Flow Mesh Cover for Integrated seat pan; up to 22x20..... \$0
 Must select integrated seat pan option above.
 Part: SMDCOVXXYYM
Air Flow Mesh Cover for Integrated seat pan; 22x20 and up..... \$23.10
 Must select integrated seat pan option above.
 Part: SMDCOVXXYYM

Stealth-Tek Cover

Stealth-Tek Cover \$0
 Part: SMDCOVXXYYT
Stealth-Tek Cover for Integrated seat pan; up to 22x20 \$23.10
 Must select integrated seat pan option above.
 Part: SMDCOVXXYYT
Stealth-Tek Cover for Integrated seat pan; 22x20 and up \$51.50
 Must select integrated seat pan option above.
 Part: SMDCOVXXYYT

Coolcore® is a research proven performance fabric technology that adapts to its environment and regulates temperature by managing heat and moisture. The proprietary construction helps manage and distribute moisture quickly throughout the fabric to enhance the evaporation and drying time.

Air Flow Mesh is equipped with fine pores that provide superior air circulation. It can improve positioning if a client is prone to sliding on other cushion cover materials. This fabric is ideal for those in hot or humid environments.

Stealth-Tek is a nylon/polyester fabric coated with polyurethane. These types of fabrics are waterproof with stretch capability and applications in medical and healthcare.

Add Polyurethane Liner (Incontinence Liner).....\$103
 Part: SMDPULXXYY

Note: If I-Style Special Modification is selected there will be a \$120 upcharge for Incontinence Liner I-Style Modification.

Add I-Style Special Modification (Incontinence Liner) \$123.60
 Part: SMDIS-L

Note: If Specified Dimensions Seat Base is selected there will be an \$85 upcharge.

Add Zipper Pouch..... \$25.75
 Part: SMDZPCOVMOD

Need Help? Call +1 (512) 715-9995
 Call toll free at +1 (800) 965-9229

Notes:

2 Basic Cushion Shape

2.1 Select Base Format*

SS353 Use increments of 1in (2.54cm)

B2 Anti-Thrust Depth: _____

Anti-Thrust Height **B** **OR**

1/2 inch (1.27 cm)	1 inch (2.54 cm)
1 1/2 inch (3.81 cm)	2 inch (5.08 cm)
2 1/2 inch (6.35 cm)	

A **OR** **A**

Anti-Thrust (AT) **B**
Adjustable Anti-Thrust modification.....\$195

A. Cushion Back Height:

B. Cushion Front Height:

Apply only to Anti-Thrust. Will display total cushion front height expected from selection.

Omit Anti-Thrust (Planar)

2.2 Select Contour Option

Expected adduction total height

C **OR** **C**

Adductor Specifications

Adductor Height (from Surface) **C**

1/2 inch (1.27 cm)	1 inch (2.54 cm)
1 1/2 inch (3.81 cm)	2 inch (5.08 cm)
2 1/2 inch (6.35 cm)	

Anti-Thrust with Adductor **OR** **Planar with Adductor**

Expected Abduction total height

E **OR** **E**

Abductor Specifications

Abductor Depth **D**
Set at 1in (2.54cm) increments

Abductor Height (from Surface) **E**
Increments of 1/2in (1.27cm)

1 inch (2.54 cm)	1 1/2 inch (3.81 cm)	2 inch (5.05 cm)
------------------	----------------------	------------------

Anti-Thrust with Abductor **OR** **Planar with Abductor**

SS355

Contoured Seat Cushion

Full contoured seat cushion requires field values highlighted on the illustration.

Full Contour with Anti-Thrust **OR** **Planar Full Contour**

Need Help? Call +1 (512) 715-9995
Call toll free at +1 (800) 965-9229

3 Cushion Foam

FOAM OPTIONS

Total Foam Thickness



Foam Options Details



Cushion Dimensions Summary

N	10in (25.40cm) to 12in (30.48cm) Width
S	13in (33.02cm) to 16in (40.64cm) Width
M	17in (43.18cm) to 20in (50.80cm) Width
L	21in (53.34cm) to 24in (60.96cm) Width

Part: SMDFO___-M-SMFRG1-0.5

Place an N, S, M or L in the part number to designate the cushion width dimensions.
 Note: Base and Middle layers can have a total of 1 1/2in (3.81cm) maximum thickness of any available foam combination.

3.2 MIDDLE LAYER

1/2in (1.27cm) Open Cell (OC)

HR Medium \$0.00
 Part: SMDFO___-M-OC3-0.5

1in (2.54cm) Open Cell (OC)

HR Medium \$0.00
 Part: SMDFO___-M-OC3-1

1/2in (1.27cm) SunMate® FRG

Extra Extra Soft \$144.20
 Part: SMDFO___-M-SMFRG1-0.5
Extra Soft \$144.20
 Part: SMDFO___-M-SMFRG2-0.5
Soft \$144.20
 Part: SMDFO___-M-SMFRG3-0.5
Medium Soft \$144.20
 Part: SMDFO___-M-SMFRG4-0.5
Medium \$144.20
 Part: SMDFO___-M-SMFRG5-0.5

1in (2.54cm) SunMate® FRG

Extra Extra Soft \$144.20
 Part: SMDFO___-M-SMFRG1-1
Extra Soft \$144.20
 Part: SMDFO___-M-SMFRG2-1
Soft \$144.20
 Part: SMDFO___-M-SMFRG3-1
Medium Soft \$144.20
 Part: SMDFO___-M-SMFRG4-1
Medium \$144.20
 Part: SMDFO___-M-SMFRG5-1

Gel Overlay

Small Gel Cube Honeycomb Overlay (.5 inch) \$225.00
 Part: SMDGOS-C-GCH-0.5

Small Gel Cube Honeycomb Overlay (1 inch) \$305.00
 Part: SMDGOS-C-GCH-1.0

Maximum Width: 14", Maximum Depth: 14".
 Must be paired with a contact layer of foam.

3.1 BASE LAYER*

1/2in (1.27cm) Open Cell (OC)

HR Medium \$0.00
 Part: SMDFO___-L-OC3-0.5

1in (2.54cm) Open Cell (OC)

HR Medium \$0.00
 Part: SMDFO___-L-OC3-1

1/2in (1.27cm) SunMate® FRG

Extra Extra Soft \$144.20
 Part: SMDFO___-L-SMFRG1-0.5
Extra Soft \$144.20
 Part: SMDFO___-L-SMFRG2-0.5
Soft \$144.20
 Part: SMDFO___-L-SMFRG3-0.5
Medium Soft \$144.20
 Part: SMDFO___-L-SMFRG4-0.5
Medium \$144.20
 Part: SMDFO___-L-SMFRG5-0.5

1in (2.54cm) SunMate® FRG

Extra Extra Soft \$144.20
 Part: SMDFO___-L-SMFRG1-1
Extra Soft \$144.20
 Part: SMDFO___-L-SMFRG2-1
Soft \$144.20
 Part: SMDFO___-L-SMFRG3-1
Medium Soft \$144.20
 Part: SMDFO___-L-SMFRG4-1
Medium \$144.20
 Part: SMDFO___-L-SMFRG5-1

3.3 CONTACT LAYER

1/2in (1.27cm) Open Cell (OC)

HR Medium \$0.00
 Part: SMDFO___-U-OC3-0.5

1in (2.54cm) Open Cell (OC)

HR Medium \$0.00
 Part: SMDFO___-U-OC3-1

1/2in (1.27cm) SunMate® FRG

Extra Extra Soft \$195.70
 Part: SMDFO___-U-SMFRG1-0.5
Extra Soft \$195.70
 Part: SMDFO___-U-SMFRG2-0.5
Soft \$195.70
 Part: SMDFO___-U-SMFRG3-0.5
Medium Soft \$195.70
 Part: SMDFO___-U-SMFRG4-0.5
Medium \$195.70
 Part: SMDFO___-U-SMFRG5-0.5

1in (2.54cm) SunMate® FRG

Extra Extra Soft \$195.70
 Part: SMDFO___-U-SMFRG1-1
Extra Soft \$195.70
 Part: SMDFO___-U-SMFRG2-1
Soft \$195.70
 Part: SMDFO___-U-SMFRG3-1
Medium Soft \$195.70
 Part: SMDFO___-U-SMFRG4-1
Medium \$195.70
 Part: SMDFO___-U-SMFRG5-1



For part numbers reference, download the addendum at StealthHub.StealthProducts.com or scan the QR code on the left.

4 Special Cut Outs

For Part Number Reference Download Addendum A.1

LEG LENGTH DISCREPANCY

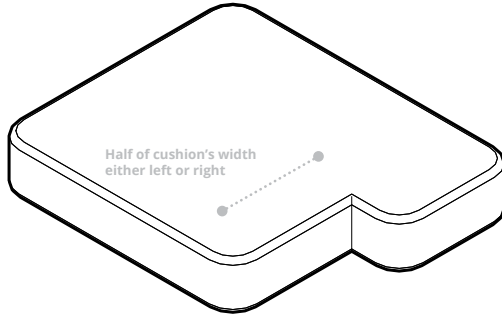

Short Left (select below)

- Short Left, 1/2in - 1.27cm Depth** \$128.75
Part: SMDLLD.5-L
- Short Left, 1in - 2.54cm Depth** \$128.75
Part: SMDLLD1-L
- Short Left, 1 1/2in - 3.81cm Depth** \$128.75
Part: SMDLLD1.5-L
- Short Left, 2in - 5.08cm Depth**..... \$128.75
Part: SMDLLD2-L

Short Right (select below)

- Short Right, 1/2in - 1.27cm Depth**..... \$128.75
Part: SMDLLD.5-R
- Short Right, 1in - 2.54cm Depth** \$128.75
Part: SMDLLD1-R
- Short Right, 1 1/2in - 3.81cm Depth**..... \$128.75
Part: SMDLLD1.5-R
- Short Right, 2in - 5.08cm Depth** \$128.75
Part: SMDLLD2-R

ISCHIAL RELIEF

Viscous Gel is intended for end users who have poor trunk control and need better immersion to stabilize the pelvis.

Ultra-Lite Gel is intended for end users who need more movement and less shear, i.e. Pediatric users.

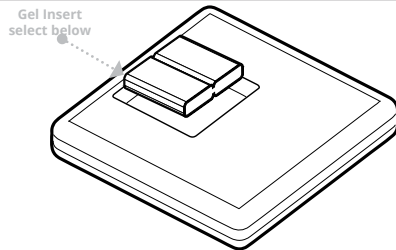

- Ischial Relief w/Viscous Gel** \$61.80
Small (17" W and less)
Part: SMDINSVISS
- Ischial Relief w/Viscous Gel** \$61.80
Large (18" W and greater)
Part: SMDINSVISL
- Ischial Relief w/Ultra-Lite Gel** \$118.45
Small (17" W and less)
Part: SMDINSVGUS
- Ischial Relief w/Ultra-Lite Gel** \$118.45
Large (18" W and greater)
Part: SMDINSVGUL

RELIEFS

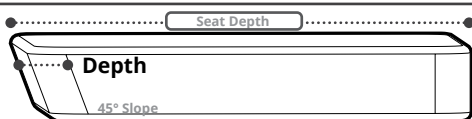

- Hamstring Relief 1in (2.54cm)** \$56.65
Part: SMDHSR1
- Hamstring Relief 2in (5.08cm)** \$56.65
Part: SMDHSR2

GROWTH ADAPTATIONS

i-Style

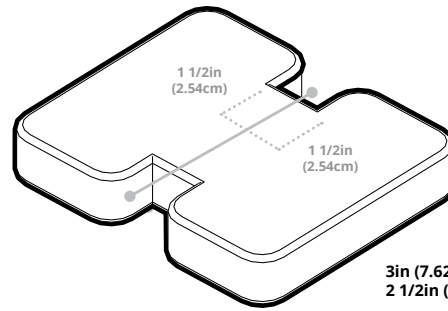

i Style \$242.05

Growth Notch

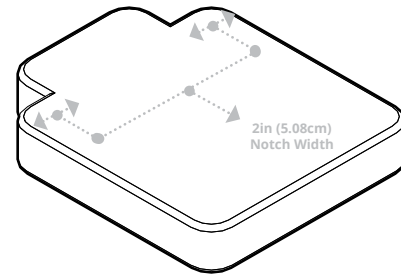

- Growth Notch, 1in (2.54cm) Depth**..... \$30.90
Part: SMDGN1
- Growth Notch, 2in (5.08cm) Depth**..... \$30.90
Part: SMDGN2
- Growth Notch, 3in (7.62cm) Depth**..... \$30.90
Part: SMDGN3

IT WELL

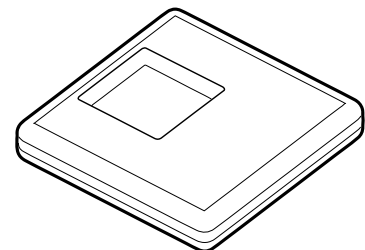

- IT Well, Small** \$59.00
Part: SMDITWSM
- IT Well, Large** \$66.00
Part: SMDITWLG

COCCYX CUT-OUT

- Coccygeal Cut-Out, 4" W x 4"D** \$99.00
Part: SMDCCO1
- Custom Coccyx Cut-out** \$109.00
Part: SMDCCO2

Width: _____ X Depth: _____

SEAT RAIL CUT-OUT

- Seat Rail Cut, 1.5" wide, 1" tall** \$124.00
Part: SMDSRC15-1.0
- Seat Rail Cut, 1.5" wide, 1.5" tall** \$124.00
Part: SMDSRC15-1.5
- Seat Rail Cut, 1.5" wide, 2" tall** \$124.00
Part: SMDSRC15-2.0
- Custom Seat Rail Cut**..... \$217.00
Part: SMDSRC15-CUS

_____ Width x _____ Tall

5 Mounting

No Mounting

Seat Pan, Standard \$128.75

Seat Pan, Large \$257.50
 22in and greater Width or Depth

SMDSP SW SD

SW Numeric value for Seat Width

SD Numeric value for Seat Depth

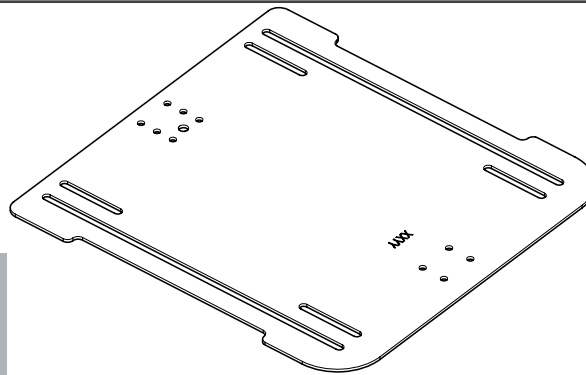

Also available
 ADI™ Carbon
 Fiber Seat Pans
 for weights
 under 250 lb

Seat Pan Hardware

No Hardware

Tubing: Select tubing size if Seat Pan Hardware is selected.

3/4in (1.91cm) 7/8in (2.22cm) 1in (2.54cm)

Trouble Free, 2Pt..... \$360.50

Part: SMDHWTF2P-034

Trouble Free, 4Pt..... \$463.50

Part: SMDHWTF4P-034

J & L, 2Pt..... \$213.75

Part: SMDHWJL2P-034

J & L, 4Pt..... \$213.75

Part: SMDHWJL4P-034

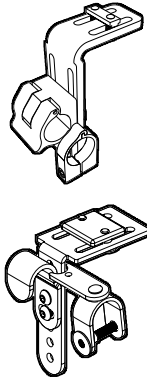

Knob, 2pt..... \$314.15

Part: SMDHWKN2P-034

Knob, 4Pt..... \$556.20

Part: SMDHWKN4P-034

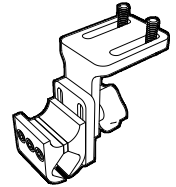

Snap-on, 2pt \$245.00

Only available with 1 inch round tubing.

Part: SMDHWSO2P-100

Snap-on, 4Pt \$310.00

Only available with 1 inch round tubing

Part: SMDHWSO4P-100

Optional:



Order the bracket when 2 point mounting format is selected, and the current back system does not include one. Also, consider if the seating system expects no flexing by the posterior area.

TFB 3in adjustable Seat to Back Bracket..... \$206.21
 Part: TFBMDSB

Rigidizer ACM ABS Contour Mold

Can be cut on designated ridges to the following sizes:

Small: 16in x 16in, 16in x 18in
 Medium: 18in x 16in, 18in x 18in, 18in x 20in
 Large: 20in x 18in, 20in x 20in

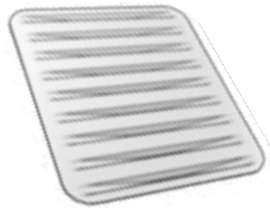

16in (40.64cm) Small Rigidizer, \$139.05 Contoured Insert

Part: SMDRGDSML

18in (40.64cm) Medium Rigidizer, \$144.20 Contoured Insert

Part: SMDRGDMED

20in (50.80cm) Large Rigidizer, \$149.35 Contoured Insert

Part: SMDRGDLRG

Rigidizer Flat ABS

Flat rigidizer final dimensions will match cushion dimensions. For part number reference download the addendum at <https://stealthhub.stealthproducts.com>

SMDRGD SW SD \$86.52

Predefined width no Wedge Kit

SMDRGD SW SD L \$198.79

Predefined width w/Large Wedge Kit

SMDRGD_XXYY..... \$138.43

Specific width no Wedge Kit

SMDRGD_XXYY-L \$258.43

Specific width w/Large Wedge Kit

SW Numeric value for Seat Width

SD Numeric value for Seat Depth

Positioning Wedge Kit

CC Positioning Wedge Kit \$146.26

Part: SMDPOP

6 Thigh Supports

Fixed		HCPCS: E1028	
One Size, Adjustable Thigh Guide, Left \$254.78 Part: UTT23119Q2-L Note: Requires the selection of a Mount		One Size, Adjustable Thigh Guide, Right \$254.78 Part: UTT23119Q2-R Note: Requires the selection of a Mount	
Flip Away		HCPCS: E1028	
Flip Away Thigh Guide - Left \$316.00 Part: UTS25100-L Note: Requires the selection of a Mount		Flip Away Thigh Guide Long - Left \$316.00 Part: UTS25300-L Note: Requires the selection of a Mount	
Flip Away Thigh Guide - Right \$316.00 Part: UTS25100-R Note: Requires the selection of a Mount		Flip Away Thigh Guide Long - Right \$316.00 Part: UTS25300-R Note: Requires the selection of a Mount	
Flip Away, Full Surface Contact		HCPCS: K0108	
UniLink Pelvic/Thigh Full Surface Contact (FSC) Option \$101.25 Part: UTPFS100 Note: Only Compatible with Flip Away Thigh Supports			
Flip Away, Thigh Guide/Thigh Full Surface Contact (FSC) Option, Left \$316.21 Part: UTS2510F-L			
Flip Away, Thigh Guide/Thigh Full Surface Contact (FSC) Option, Right \$316.21 Part: UTS2510F-R			
Flip Away, Thigh Guide/Thigh Full Surface Contact (FSC) Option, Long Left \$316.21 Part: UTS2530F-L			
Flip Away, Thigh Guide/Thigh Full Surface Contact (FSC) Option, Long Right \$316.21 Part: UTS2530F-R			
Removable		HCPCS: E1028	
Long, Multi-Angle Thigh Guide - Left \$325.50 Part: UTT6A116Q2-L Note: Must use UT800000-Q		Short, Multi-Angle Thigh Guide - Right \$325.50 Part: UTT7A116Q2-R Note: Must use UT800000-Q	
Long, Multi-Angle Thigh Guide - Right \$325.50 Part: UTT6A116Q2-R Note: Must use UT800000-Q		Long, Standard Stave Thigh Guide \$262.50 Part: UTT6A1260000 Note: Must use UT800000-Q	
Short, Multi-Angle Thigh Guide - Left \$325.50 Part: UTT7A116Q2-L Note: Must use UT800000-Q		Short, Standard Stave Thigh Guide \$262.50 Part: UTT7A1260000 Note: Must use UT800000-Q	
Mounting		HCPCS: K0108	
UniLink Hip Guide Receiver Quantum \$77.21 Part: UT800000-Q Note: Only Compatible with Removable Thigh Supports		UniLink Mount Pelvic/Thigh Bracket,..... \$54.04 Cane Mount - 1" Part: UIMPCI100	
UniLink Mount Pelvic/Thigh Bracket 90 Degree \$54.04 Part: UIMPBI090		UniLink Pelvic/Thigh 90 Degree..... \$102.68 All Season Bracket Part: UTMASIO90	
UniLink Mount Pelvic/Thigh Bracket, \$54.04 Cane Mount - 3/4" Part: UIMPCI340		UniLink Mount Track Nut - Permobil \$16.21 Part: UIMTNIPRM	
UniLink Mount Pelvic/Thigh Bracket,..... \$54.04 Cane Mount - 7/8" Part: UIMPCI780		UniLink Mount Track Nut - Quantum \$16.21 Part: UIMTNITB4	
Standard Pads		HCPCS: E0956	
3x6, Neoprene Lat Pad, Metric, 1" spacing \$72.32 Part: UTP536050300		4x10, Neoprene Lat Pad, Metric, 1" spacing \$72.32 Part: UTP540050300	
4x4, Neoprene Lat Pad, Metric, 1" spacing \$72.32 Part: UTP544050300		4x12, Neoprene Lat Pad, Metric, 1" spacing \$72.32 Part: UTP54D050300	
4x6, Neoprene Lat Pad, Metric, 1" spacing \$72.32 Part: UTP546050300		Custom Thigh Support Pad Part: UTP5CUS0300 Contact your Customer Service Representative for pricing.	
4x8, Neoprene Lat Pad, Metric, 1" spacing \$72.32 Part: UTP548050300			
Track Pads		HCPCS: E0956	
4x4 Track Pad \$101.25 Part: UTP544056100		4x10 Track Pad \$101.25 Part: UTP540056100	
4x6 Track Pad \$101.25 Part: UTP546056100		4x12 Track Pad \$101.25 Part: UTP54D056100	
4x8 Track Pad \$101.25 Part: UTP548056100		Custom Thigh Track Pad \$157.95 Part: UTP5CUS06100	

7 Pelvic Belts

HCPCS: E0978

2PT, Non Padded

- Non-Padded Belt, Push Button, 1", Single Pull..... \$47.38**
Part: IFPB5110
- Non-Padded Belt, Push Button, 1.5", Single Pull..... \$47.38**
Part: IFPB5210
- Non-Padded Belt, Push Button, 2", Single Pull..... \$47.38**
Part: IFPB5310

- Non-Padded Belt, Side Release, 1", Single Pull..... \$41.20**
Part: IFPB6110
- Non-Padded Belt, Side Release, 1.5", Single Pull..... \$41.20**
Part: IFPB6210

2PT, Padded, Single Pull, Push Button

- Pelvic Belt, Push Button, 1", Single Pull, \$88.58**
Extra Small Pads (4.5 in)
Part: IFPB5111
- Pelvic Belt, Push Button, 1", Single Pull, \$88.58**
Small Pads (5.5 in)
Part: IFPB5112
- Pelvic Belt, Push Button, 1.5", Single Pull, \$88.58**
Medium Pads (7.5 in)
Part: IFPB5213

- Pelvic Belt, Push Button, 1.5", Single Pull, \$88.58**
Large Pads (9.5 in)
Part: IFPB5214
- Pelvic Belt, Push Button, 2", Single Pull, \$88.58**
Large Pads (9.5 in)
Part: IFPB5314
- Pelvic Belt, Push Button, 2", Single Pull, \$88.58**
X-Large Pads (11.5 in)
Part: IFPB5315

2PT, Padded, Single Pull, Side Release

- Pelvic Belt, Side Release, 1.5", Single Pull, \$82.40**
Medium Pads (7.5 in)
Part: IFPB6213
- Pelvic Belt, Side Release, 1.5", Single Pull, \$82.40**
Large Pads (9.5 in)
Part: IFPB6214

- Pelvic Belt, Side Release, 2", Single Pull, \$82.40**
Large Pads (9.5 in)
Part: IFPB6314
- Pelvic Belt, Side Release, 2", Single Pull, \$82.40**
X-Large Pads (11.5 in)
Part: IFPB6315

2PT, Padded, Dual Pull, Push Button

- Pelvic Belt, Push Button, 1", Dual Pull, \$88.58**
Extra Small Pads (4.5 in)
Part: IFPB5121
- Pelvic Belt, Push Button, 1", Dual Pull, \$88.58**
Small Pads (5.5 in)
Part: IFPB5122
- Pelvic Belt, Push Button, 1.5", Dual Pull, \$88.58**
Medium Pads (7.5 in)
Part: IFPB5223

- Pelvic Belt, Push Button, 1.5", Dual Pull, \$88.58**
Large Pads (9.5 in)
Part: IFPB5224
- Pelvic Belt, Push Button, 2", Dual Pull, \$88.58**
Large Pads (9.5 in)
Part: IFPB5324
- Pelvic Belt, Push Button, 2", Dual Pull, \$88.58**
X-Large Pads (11.5 in)
Part: IFPB5325

2PT, Padded, Side Release, Dual Pull

- Pelvic Belt, Side Release, 1.5", Dual Pull, \$82.40**
Medium Pads (7.5 in)
Part: IFPB6223
- Pelvic Belt, Side Release, 1.5", Dual Pull, \$82.40**
Large Pads (9.5 in)
Part: IFPB6224

- Pelvic Belt, Side Release, 2", Dual Pull, \$82.40**
Large Pads (9.5 in)
Part: IFPB6324
- Pelvic Belt, Side Release, 2", Dual Pull, \$82.40**
X-Large Pads (11.5 in)
Part: IFPB6325

4PT, Linear

- Linear Style Pad, Push Button, 1 in, 4Pt \$133.90**
Extra Small Pads (4.5 in)
Part: IFPB5145
- Linear Style Pad, Push Button, 1 in, 4Pt \$133.90**
Small Pads (5.5 in)
Part: IFPB5146

- Linear Style Pad, Push Button, 1 in, 4Pt \$133.90**
Medium Pads (7.5 in)
Part: IFPB5147
- Linear Style Pad, Push Button, 1 in, 4Pt \$133.90**
Large Pads (9.5 in)
Part: IFPB5148

Retractable Pelvic Belt

- Pelvic Belt, Push Button, 2", Retractable..... \$172.53**
Part: IFRB5350



+1 (512) 715-9995
+1 (800) 965-9229 Toll Free
+1 (512) 715-9954 Fax
+1 (800) 806-1225 Toll Free Fax
104 John Kelly Drive,
Burnet, TX 78611

information@sw.stealthproducts.com
www.stealthproducts.com
[facebook.com/StealthProducts](https://www.facebook.com/StealthProducts)
twitter.com/stealthproducts