

TFB

All Purpose (Knob) Hardware

The True Forming Back, or TFB, has been created to provide extreme comfort, unparalleled customization options and trouble-free adjustability. The hardware is durable, easily accessible, and is hidden with a hook-and-loop attached back for a clean, sleek look.

Item	ID	Part Number	Description	Qty.
A. Mount				
	A1	TFB200-06	T-Nut	1
	A2	SSS100-125/126	Back L-Bracket 90° L/R	1
	A3	1/4 SSW	1/4" Stainless Steel Washer	2
	A4	1/4-20 x 5/8" BHS	1/4-20 x 5/8" Button Head Screw	2
B. Latch Assembly				
	B1	3/8-16 PLK	3/8-16 Plastic Lobe Knob	1
	B2	-	3/8-16 E-Clip	1
	B3	SSS100-11-01	Universal Back Mount	1
	B4	3/8-16 x 1 3/4" BHS	3/8-16 x 1 3/4" Button Head Screw	1
C. Back-Post Clamp				
	C1	SSS100-11-02	Tube Clamp	1
	*	SSS100-11-05	7/8" Tube Spacer (not pictured)	1
	C2	SSS100-11-04	1" Tube Spacer	1
	C3	SSS100-11-03	Tube Clamp Bracket	1
	C4	1/4-20 LNN	1/4-20 Low Profile Lock Nut w/Nylon	2
	C5	1/4-20 x 1/2 SHS	1/4-20 x 1/2" Socket Head Screw	2
C6	1/4-20 x 1 1/4 SHS	1/4-20 x 1 1/4" Socket Head Screw	2	

Installation and Use

The All-Purpose (Knob) hardware includes features such as angle, width, and depth adjustments.

Angle Adjustment

Step One:

Loosen the Knob (B1) on the Latch Assembly (B).

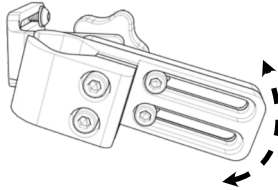
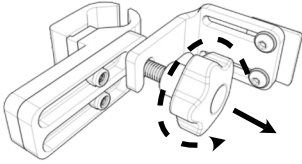

Step Two:

Position the Back-Post Clamp (C) to the required angle.

Step Three:

Secure the Back-Post Clamp (C) in place by tightening the Knob (B1).

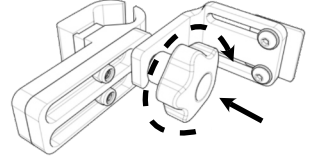

Step Four: Repeat for other mounting hardware as needed.

Width Adjustment

Step One:

Loosen the 1/4-20 x 5/8" Button Head Screws (A4) on the Mount (A).

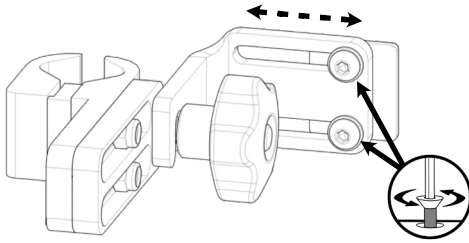

Step Two:

Position the Mount (A) to the required width.

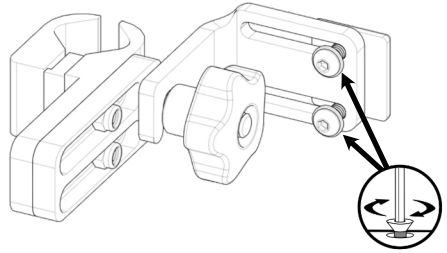

Step Three:

Secure the Mount (A) in place by tightening the screws (A4).

Depth Adjustment

Step One:

Loosen the 1/4-20 x 1/2" Socket Head Screws (C5) on the Back-Post Clamp (C).

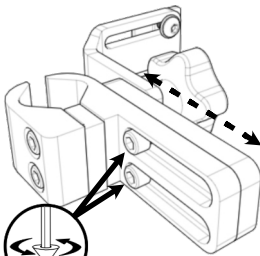

Step Two:

Position the Back-Post Clamp (C) to the required depth.

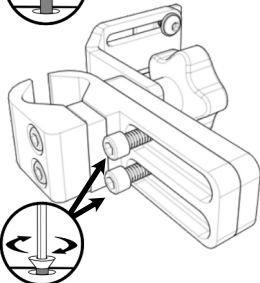

Step Three:

Secure the Back-Post Clamp (C) in place by tightening the screws (C5).

Cane Compatibility

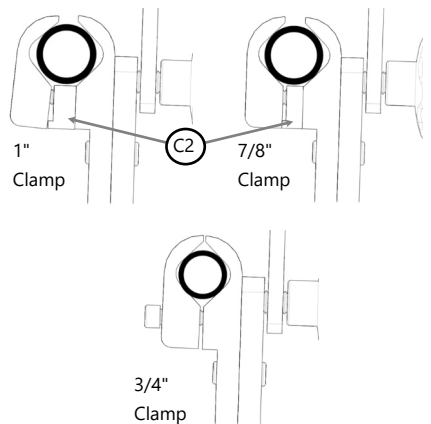

The All Purpose (Knob) Hardware is initially configured to fit a 3/4" cane. It can be adapted to fit a 1" cane and 7/8" cane with the large and small Tube Spacers (C2) as shown above.

Clamp Assembly to Wheelchair Back Post

Step One: Visually determine the desired height of the TFB. Mark on each back post the needed location to attach the clamp assemblies.

STEP 1



Step Two: Loosen the 1/4-20 x 1 1/4" socket head screws (C6) to allow the Tube Clamp (C1) and Tube Clamp Bracket (C2) to widen and slide over the top of the back post. Slide it to the mark made in Step One and proceed to Step Three.

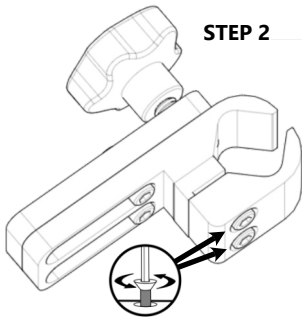

STEP 2

Step Three: Loosen the 1/4-20 x 1/2" socket head screws (C5) to adjust the position of the knob horizontally.

STEP 3

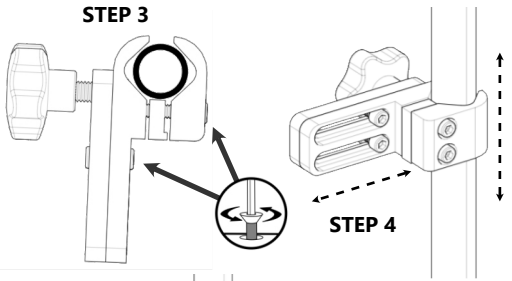

STEP 4

STEP 5

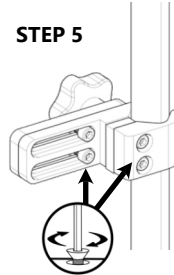

Step Five: After preliminary adjustments have been completed, tighten all screws to hold the clamps in place.

Mounting Hardware to the Back

Step One: Take one of the T-Nuts (A1) and place it in the slot on the front (user side) of the aluminum shell.

STEP 1

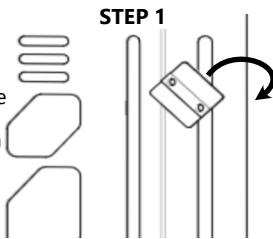

Step Three: Position the back in front of the back posts and slide the bracket tabs over the threaded shaft of the knobs (B1) on both sides. Hand-tighten the knobs (B1) to secure the back to the clamps.

STEP 3

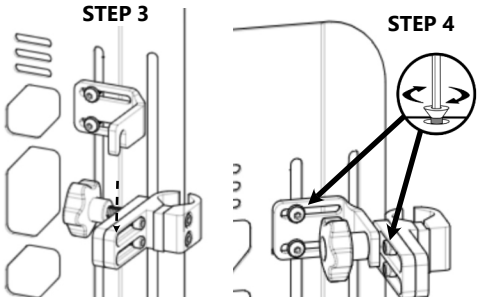

STEP 4

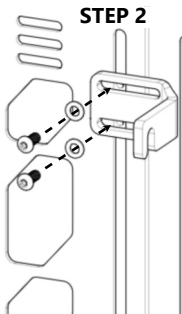

STEP 2

Step Two: Line up the L-Brackets (A2) with the T-Nuts (A1) through the slots in the back and ensure it is in the correct horizontal and vertical position. Secure each bracket with two 1/4-20 x 5/8" button head screws (A4) and two 1/4" washers (A3) as shown to the left.

Step Four: Tighten the screws (A4, C5) to secure the bracket and clamps to the back.

Important

These products are designed to be fitted, applied, and installed exclusively by a health care professional trained for these purposes. The fitting, application and installation by a non-qualified individual could result in serious injury. **Stealth Products, LLC** accepts no liability for personal injury or damage that may arise from the failure of the user or other persons to follow the recommendations, warnings, and instructions in this manual. **Stealth Products** does not hold responsibility for final integration of final assembly of product to end user. **Stealth Products** is not liable for user death or injury. Initial setup and driving should be done in an open area free of obstacles until the user is fully capable of driving safely.

Before you begin using this product, it is important that you read and understand the content of these installation and operating instructions. Product misuse due to failure to adhere to instructions and warnings in this document will void your warranty and may result in property damage, injury or death. Always keep the operating instructions in a safe place so they may be referenced as necessary. If this document contains information you do not understand or if there are concerns about safety or operation, contact your provider.

All information, pictures, illustrations and specifications are based on the product information available at the time of printing, and are representative examples. They are not intended to be exact descriptions of the various parts of the product. Instructions are written with the expressed intent of use with standard configurations. They also contain important safety and maintenance information. For assistance with advanced configurations or options, contact your provider or **Stealth Products** at (512) 715-9995 or toll free at (800) 965-9229.

Immediately discontinue use if any function is compromised, if parts are missing or loose or if any component shows signs of excessive wear. Consult with your provider for repair, adjustment or replacement. You can download additional copies of this manual by visiting <https://stlpro.site/stealth-docs/> and searching for "All Purpose Adjustable Knob" in the document manager.

Warranty

Our products are designed, manufactured, and produced to the highest of standards. If any defect in material or workmanship is found, **Stealth Products** will repair or replace the product at our discretion. Any implied warranty, including the implied warranties of merchantability and fitness for a particular purpose, shall not extend beyond the duration of this warranty. **Stealth Products, LLC** does not warrant damage due to, but not limited to, misuse, abuse, or misapplication of products and modification of product without written approval from **Stealth Products, LLC**. Any alteration or lack of serial number, where applicable, will automatically void this warranty. **Stealth Products, LLC** is liable for replacement parts only, and is not liable for any incurred labor costs. No person is authorized to alter, extend, or waive the warranties of **Stealth Products, LLC**.

Please visit <https://stlpro.site/returns-n-warranty> to learn more about our warranty and returns policy.

About Us

Stealth Products is committed to 100% customer satisfaction. Your complete satisfaction is important to us. Please contact us with suggestions or feedback to help us improve the quality and usability of our products.

You may reach us at:

 **Stealth Products, LLC**
104 John Kelly Drive,
Burnet, TX 78611

Phone: (512) 715-9995 Toll Free: (800) 965-9229
Fax: (512) 715-9954 Toll Free: (800) 806-1225
info@stealthproducts.com - www.stealthproducts.com

EC REP MDSS GmbH Schiffgraben 41 30175 Hannover, Germany	CH REP SODIMED SA Chemin Praz Devant 12 1032 Romanel sur-Lausanne, Switzerland	UK Authorized Representative MDSS-UK RP 6 Wilmslow Road, Rusholme Manchester M14 5TP, United Kingdom
---	---	---

