

TFB

Quick Release

The True Forming Back, or TFB, has been created to provide extreme comfort, unparalleled customization options and trouble-free adjustability. The hardware is durable, easily accessible, and is hidden with a hook-and-loop attached back cover for a clean, sleek look.

Item	ID	Part Number	Description	Qty.
A. Mount				
	A1	TFB200-66	T-Nut, True Forming Back	2
	A2	TFB200-53	L-Bracket	1
	A3	1/4 SSW	1/4" Stainless Steel Washer	2
	A4	1/4-20 x 5/8 BHS	1/4-20 x 5/8" Button Head Screw	2
B. Latch Assembly				
	B1	1/4-20 LNN	1/4-20 Nylon Lock Nut	2
	B2 ¹	8-32 x 3/16 BHS	8-32 x 3/16" Button Head Cap Screw	2
	B3 ¹	8 x 3/4 FW	8 x 0.75" Fender Metal Washer	2
	B4 ¹	1/4 x .28 x .74 x .06 FW	1/4" Flat Plastic Washer	2
	B5 ¹	BR5012	Removable Boomerang	1
	B6 ¹	BR5013	Lock Piece	1
	B7 ¹	8-32 x 1/4 x 5/16 FTS	8-32 x 1/4" x 5/16" Female Threaded Standoff	1
	B8	1/4 SSW	1/4" Stainless Steel Washer	2
	B9	1/4-20 x 5/8 BHS	1/4-20 x 5/8" Button Head Cap Screw	2
C. Back-Post Clamp				
	C1	10-32 x 1/2 BHS	10-32 x 1/2" Button Head Screw	4
	C2	BR5008-1	Removable Pulley	2
	C3	1/4x1 10-32 TRS	1/4" x 1" 10-32 TRS	2
	C4	BR5034	Backing Pin	1
	C5	BR5003	Quick Release Seatback - Inside Clamp	1
	C6	BR5002	Quick Release Seatback - Outside Clamp	1
	C7	M5 FW	M5 Flat Washer	2
	C8 ²	M5 x 0.8 x 25mm SHS	M5 x 0.8 x 25mm Socket Head Cap Screw	2

¹ Note: Items B2-B7 are pre-assembled as a single piece ² M5 X 0.8 X 22mm SHS (2) included for 3/4" and 7/8" installations.

Installation and Use

The Quick Release hardware includes features such as angle, width, and depth adjustments.

Angle Adjustment

- Allows approximately 20° of adjustment
- There is no loss of seat depth with angle adjustment

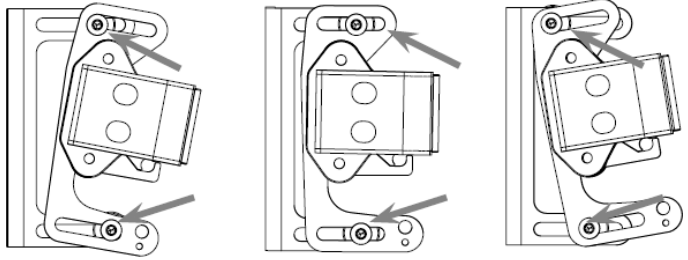

Width Adjustment

- Approximately 1 inch (2.54cm) of width adjustment.
- By loosening the screws (A4) on the mount, the hardware can be adjusted horizontally to increase the space between the two quick release assemblies.

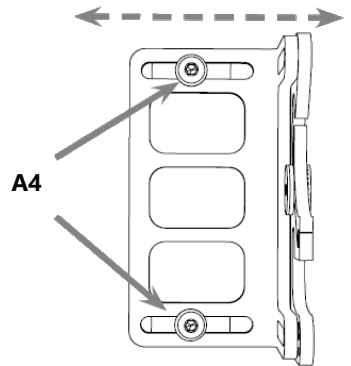

Depth Adjustment

- Approximately 1.25 inches (3.18 cm) of depth adjustment available.
- Center mounting of hardware positions the back cushion valley behind the back posts.
- Forward mounting of hardware positions the back cushion forward 5/8 in.
- Aft mounting of the hardware positions the back cushion rearward 5/8 in.

B1/B9

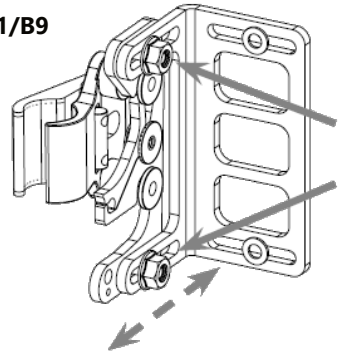

Cane Compatibility

- The Quick Release hardware mounts to multiple diameter cane clamps without the use of spacers.
- Hardware is compatible with 1 in., 3/4 in., and 7/8 in. cane diameters.

NOTE: The 25mm SHS is intended ONLY for 1" cane. Use the included 22mm SHS for 3/4" and 7/8" installations.

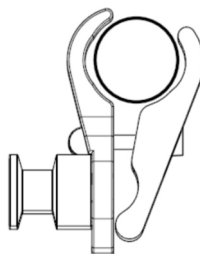

1" Clamp

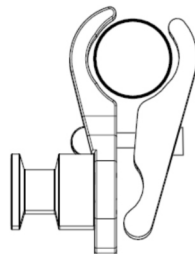

7/8" Clamp

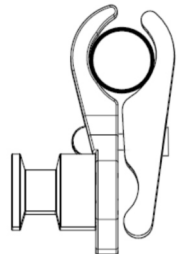

3/4" Clamp

Mounting Hardware to the Back

STEP 1

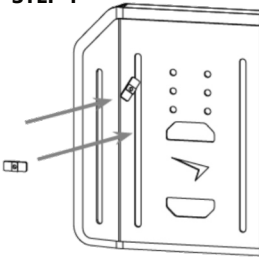

STEP 2

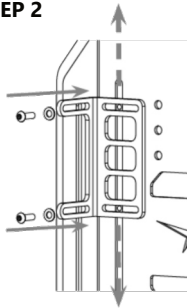

Step One:

Take one of the T-Nuts (A1) and place it in the slot on the front side (user side) of the aluminum shell.

Step Two:

Line up the L-Bracket (A2), on the rear of the aluminum shell, with the T-Nut (A1) and ensure it is in the appropriate horizontal and vertical position. Secure it with a 1/4-20 x 5/8" button head screw (A4) and a 1/4" washers (A3). Tighten the screw to hold the bracket in place. Repeat for the second T-Nut on this bracket.

STEP 3

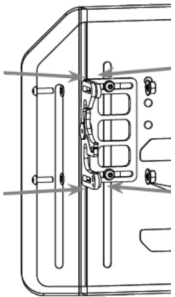

STEP 4

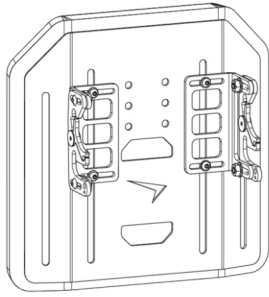

Step Three:

Position the latch assembly (B) on the L-Bracket (A2) and attach it with two 1/4-20 x 5/8" button head screws (B9) with 1/4" washers (B8) on one side and a 1/4-20 lock nut (B1) on the other. Make sure the assembly is positioned at the correct depth and angle needed prior to tightening the screws.

Step Four:

Repeat Steps 1 through 3 to install the second hardware assembly.

Clamp Assembly to Wheelchair Back Post

Step One:

Visually determine the desired height of the TFB. Mark on each back post the needed location to attach the clamp assemblies.

Step Two:

Loosen the 1/4-20 x 7/16" socket head cap screws (C8) and with two fingers, pinch and hold the back of the post clamp open. Slide the clamp assembly over the top of the back post (receiving post facing inward). (Screws do not have to be completely removed from hardware to slide clamp over the post.)

Step Three:

Slightly tighten each screw (C8*). Align clamp assembly parallel to the wheelchair seat base.

Step Four:

To achieve proper alignment, slightly move the mounting hardware in or out and/or up and down. Make adjustments until the backrest smoothly attaches and removes from the top and bottom receiving posts.

Step Five:

After final adjustments are complete, tighten all screws (C8*). This will ensure secure placement and safe operation.

STEP 1



STEP 2

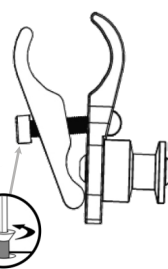

STEP 3

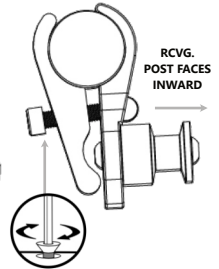

STEP 4

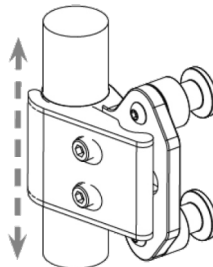

STEP 5

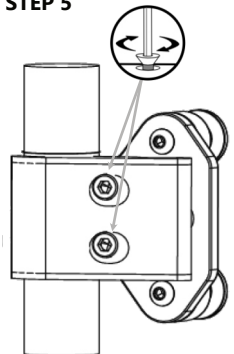

* NOTE: The 25mm SHS is intended ONLY for 1" cane. Use the included 22mm SHS for 3/4" and 7/8" installations.

WC20 Transit Information

The Quick Release mounting hardware has met WC20 and ISO16840-4 requirements and provisions. The hardware can be ordered as a WC20-approved item with transit pins. Transit pins were added to the hardware to ensure secured points in the event that the Quick Release hardware could possibly become loose during transit and detach from the ADI back.

NOTICE

Keep these pins attached to the chair at all times.

WC20 establishes design and performance requirements and test methods for complete seating systems that consist of a seat, back support, and attachment hardware.

CAUTION

The WC20 approved Quick Release Hardware and TFB backs should only be used as described in the manufacturer's instructions.

DANGER

The WC20 approved Quick Release Hardware and TFB backs are designed **ONLY** for use with wheelchair frames that have been successfully crash tested to the frontal-impact requirements of RESNA WC-4:2012, Section 19.

General Guidelines

- Attach the tie-down straps only to the designated, labeled transit security points.
- Tighten the straps sufficiently to remove all slack. Never attach tie-downs to adjustable, moving, or removable parts of the wheelchair.
- Position the anchor points for the rear tie-down straps directly behind the rear securement points on the wheelchair.
- The front tie-down straps should anchor to floor points that are spaced wider than the wheelchair to provide increased lateral stability.

Before Transit

- Clients who use wheelchairs should transfer to the vehicle seat and use the vehicle-installed occupant restraint systems.
- Prior to transporting, always double-check the tie-downs and hardware.
- On tie-downs and restraints, look for tears or worn webbing straps. Replace as necessary.
- Look for damaged hooks or loose tie-down hardware.
- On the seating system, check for loose screws attaching the seat hardware to the back. Check for loose screws attaching the hardware to the seat. These should be snug and not over-tightened.
- The Quick Release hardware should be securely attached to the back, and the transit pins should be properly inserted into the hardware.

Belt Placement

- The pelvic belt restraint should be worn low, across the front of the pelvis near the junction of the pelvis and thigh.
- The belt restraint buckle of three-point belt restraints should be placed in contact with the occupant's body and away from wheelchair components.
- The junction of the shoulder belt and pelvic belt of three-point belt restraints should be located near the hip opposite the shoulder over which the diagonal belt crosses and not near the midline of the occupant.

Proper Positioning of Belts on Occupants

- Upper torso belt restraints should fit directly over, and in contact with, the middle of the shoulder.

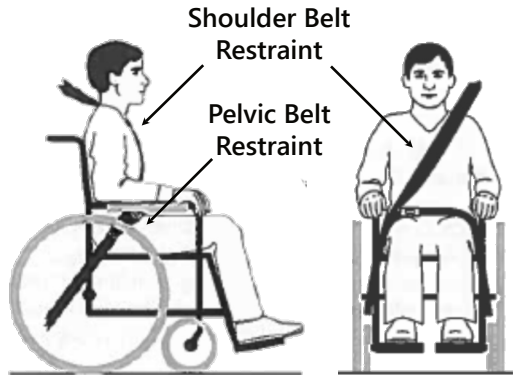

Belt restraints should not be routed outside of the wheelchair, over the wheelchair's wheels, or over the wheelchair arm supports and should not be held away from the body by wheelchair components and parts.



DANGER

The WC20 approved Quick Release hardware and the TFB backs are designed specifically for occupancy when used on wheelchairs that are facing forward in motor vehicles.



CAUTION

Belt restraints should be adjusted to fit as snugly as possible, consistent with user comfort.

SAFETY

Belt restraints should be positioned on the wheelchair occupant in accordance with WTORS manufacturer instructions.

Both pelvic belt and shoulder belt restraints that comply with RESNA WC-4:2012, Section 18 and/or 4.6, 5.2, 5.3 of RESNA WC-4:2012, Section 19 should be used to limit occupant movement in a crash and reduce the likelihood of occupant ejection from the vehicle and/or injurious contact of the occupant with the vehicle interior.

The pelvic belt should be angled between 30° and 75° horizontally when viewed from the side, and ideally between 45° and 75° horizontally, as shown in the figure to the right.

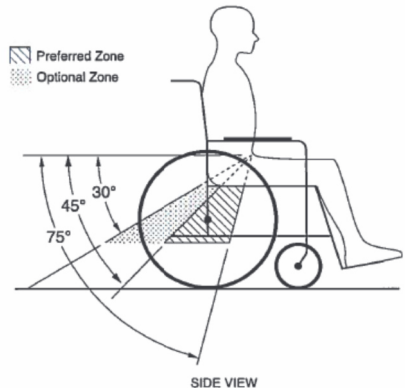

WARNING

Back supports with adjustable recline angles should not be tilted back more than 30° to the vertical during travel in vehicles unless necessary for the medical and postural needs of the occupant.

WC20 Transit Information

WARNING

If the back support must be adjusted to an angle that is greater than 30° to the vertical during travel, the upper shoulder-belt anchor point should be adjusted rearward to maintain belt contact with the wheelchair occupant's shoulder and chest.

Trays

Wheelchair-mounted rigid trays that are not specifically designed for use during travel in a motor vehicle should be:

- Removed and secured separately in the vehicle.
- Secured to the wheelchair so they will not break free in a crash.
- Positioned with a gap of at least 3 in. (7.6 cm) between the back edge of the tray and the wheelchair occupant's abdomen and/or chest so as not to interfere with proper belt-restraint use.
- Fitted with energy-absorbent padding between the back edge of the tray and the wheelchair occupant.

SAFETY

Belt restraints should not be worn twisted or in a manner that reduces the area of contact of the belt webbing with the occupant.

User Safety

The use of a postural pelvic belt attached to the wheelchair base or seat frame is encouraged during travel, but these belts should be positioned so that they do not interfere with the proper positioning of crash-worthy belt restraints, and they should not be relied upon for occupant protection in crash situations unless the postural belt has been designed to comply with, and perform to, the requirements of 4.6, 5.2, and 5.3 of RESNA WC-4:2012, Section 19.

Sufficient forward and rearward clear space should be provided around the wheelchair occupant.

The forward clear-space (FCZ) needs to be larger when a shoulder-belt restraint is not used.

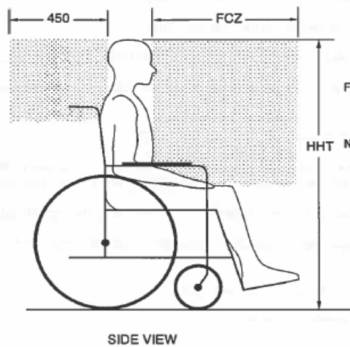
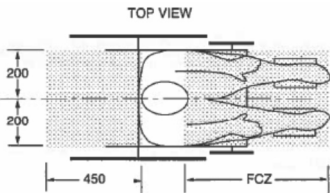

FCZ = 650 mm with upper torso restraint
= 950 mm with only pelvic restraint

HHT NOTE: It is strongly recommended that both pelvic and upper-torso belts be used.

DANGER

The WC20-approved Quick Release hardware and TFB backs have been designed to accommodate the proper use of vehicle-anchored belt restraints and the ratings of the seating systems with regard to ease of properly positioning vehicle-anchored belt restraints on the wheelchair passenger, and the degree to which proper positioning of the belt restraints can be achieved.

DANGER

Alterations or substitutions should not be made to the seating system or its parts and components without consulting the manufacturer.

Hardware Installation

After the hardware has been installed, adjusted to the user's needs, and securely fastened, insert the transit pins into the locking levers.

The key ring, connected to the pin, will need to be attached to the hardware. A small, pre-drilled hole near the base of the hardware is designated for the key ring.

Once the key ring is installed, slide the pin through the latch assembly.

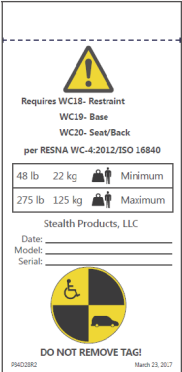
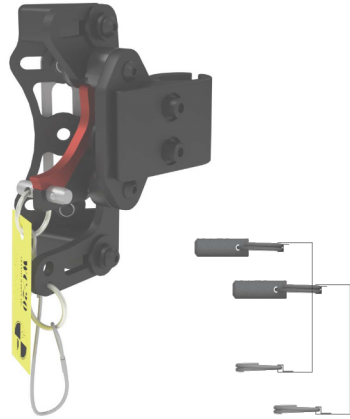

WC20 Label

The WC20 label will need to be secured to the cover of the TFB back if the WC20 pins have been ordered separately from the back and hardware (it will be installed at the factory if items are ordered together). The label must be permanently affixed to the cover in order to be WC20 compliant.

Removing the Transit Pin

When the chair is not in transit, the transit pins can be removed and placed in pre-drilled retaining holes on the hardware.



Image shows Quick Release hardware with transit pin installed in latch assembly, ready for transit.



Image shows Quick Release hardware with transit pin placed in pre-drilled retaining hole. NOT ready for transit.

Pin should always be placed in this retaining hole when not in use, to prevent damage to the chair or injury to the user.

⚠ DANGER

The WC20 approved Quick Release hardware and TFB backs are designed **ONLY** for use with wheelchair frames that have been successfully crash tested to the frontal impact requirements of RESNA WC-4:2012, Section 19.

⚠ DANGER

The WC20 approved Quick Release hardware and TFB backs **MUST** be used on a wheelchair frame that provides four securement points and pelvic-belt anchor points that conform to the requirements of RESNA WC-4:2012, Section 19.

Important

These products are designed to be fitted, applied, and installed exclusively by a health care professional trained for these purposes. The fitting, application and installation by a non-qualified individual could result in serious injury. **Stealth Products, LLC** accepts no liability for personal injury or damage that may arise from the failure of the user or other persons to follow the recommendations, warnings, and instructions in this manual. **Stealth Products** does not hold responsibility for final integration of final assembly of product to end user. **Stealth Products** is not liable for user death or injury. Initial setup and driving should be done in an open area free of obstacles until the user is fully capable of driving safely.

Before you begin using this product, it is important that you read and understand the content of these installation and operating instructions. Product misuse due to failure to adhere to instructions and warnings in this document will void your warranty and may result in property damage, injury or death. Always keep the operating instructions in a safe place so they may be referenced as necessary. If this document contains information you do not understand or if there are concerns about safety or operation, contact your provider.

All information, pictures, illustrations and specifications are based on the product information available at the time of printing, and are representative examples. They are not intended to be exact descriptions of the various parts of the product. Instructions are written with the expressed intent of use with standard configurations. They also contain important safety and maintenance information. For assistance with advanced configurations or options, contact your provider or **Stealth Products** at (512) 715-9995 or toll free at (800) 965-9229.

Immediately discontinue use if any function is compromised, if parts are missing or loose or if any component shows signs of excessive wear. Consult with your provider for repair, adjustment or replacement. You can download additional copies of this manual by visiting <https://stlpro.site/stealth-docs/> and searching for "P136D546" in the document manager.

Warranty

Our products are designed, manufactured, and produced to the highest of standards. If any defect in material or workmanship is found, **Stealth Products** will repair or replace the product at our discretion. Any implied warranty, including the implied warranties of merchantability and fitness for a particular purpose, shall not extend beyond the duration of this warranty. **Stealth Products, LLC** does not warrant damage due to, but not limited to, misuse, abuse, or misapplication of products and modification of product without written approval from **Stealth Products, LLC**. Any alteration or lack of serial number, where applicable, will automatically void this warranty. **Stealth Products, LLC** is liable for replacement parts only, and is not liable for any incurred labor costs. No person is authorized to alter, extend, or waive the warranties of **Stealth Products, LLC**.

Please visit <https://stlpro.site/returns-n-warranty> to learn more about our warranty and returns policy.

About Us

Stealth Products is committed to 100% customer satisfaction. Your complete satisfaction is important to us. Please contact us with suggestions or feedback to help us improve the quality and usability of our products.

You may reach us at:

 **Stealth Products, LLC**
104 John Kelly Drive,
Burnet, TX 78611

Phone: (512) 715-9995 Toll Free: (800) 965-9229
Fax: (512) 715-9954 Toll Free: (800) 806-1225
info@stealthproducts.com - www.stealthproducts.com

EC REP MDSS GmbH Schiffgraben 41 30175 Hannover, Germany	CH REP SODIMED SA Chemim Praz Devant 12 1032 Romanel sur-Lausanne, Switzerland	UK Authorized Representative MDSS-UK RP 6 Wilmslow Road, Rusholme Manchester M14 5TP, United Kingdom
---	---	---

