

Stealth Products[®]



**Alternative
Drive Controls**



Mushroom Joystick

Owner's Manual - Maintenance Guide

Proportional Mushroom Joystick

Customer Satisfaction	i
General.....	i
Important Information	ii-iii
Warranty	ii
Supplier Reference	ii
Warning Labels	iii
Limited Liability.....	iii
Testing	iii
Design and Function	1-2
Intended Use	1
Features	1
Mounting	1
User Transfer	1
Moving the Chair	1
Terrain Safety	1
Joystick Safety	2
Comfort and Ergonomics.....	2
Safe Driving.....	2
Installation	3
Joystick Operation	3
Prior to Operation.....	3
Joystick Setup.....	3
Installation Plan	3
Q-Logic™ Setup	4-10
Q-Logic 2.....	4
Q-Logic Proportional Joystick Setup.....	5
Center Deadband.....	6
Axis Deadband	6
Tremor Suppression	6
Assign Direction Function.....	7
Switch Operations.....	7
Joystick Calibration.....	7
Joystick Throw	7
Q-Logic 3.....	8
Joystick Setup.....	8
Joystick Calibration.....	8

Joystick Throw	9
Assign Direction	9
Center Deadband.....	9
Tremor Suppression	10
Switch Operation.....	10
R-net™ Setup	11-13
R-net Omni Setup.....	11
Joystick Recognition	12
Joystick Calibration.....	12
R-net Proportional Joystick Setup.....	13
Throw	13
Axis Orientation	13
Testing	14
Integrity Test	14
Operational Test	14
Test Drive.....	14
Stop Test	14
First-Time Use.....	15
Dealer Assistance	15
User Testing.....	15
Conditions of Use	15
Environment Safety	15
Care and Maintenance.....	16
Maintenance Check.....	16
Water Contact	16
Cleaning.....	16
Electromagnetic Interference	17
Dimensions.....	17
Required Force.....	17
Notes	23-25

Customer Satisfaction

Stealth Products is committed to 100% customer satisfaction. Your complete satisfaction is important to us. Please contact us with feedback or suggestions to help us improve the quality and usability of our products.

You may reach us at:



Stealth Products, LLC

104 John Kelly Drive, Burnet, TX 78611

Phone: (512) 715-9995

Fax: (512) 715-9954

Toll Free: (800) 965-9229

Toll Free: (800) 806-1225

info@stealthproducts.com

www.stealthproducts.com



EC REP MDSS GmbH Schiffgraben 41 30175 Hannover Germany	CH REP SODIMED SA Chemin Praz Devant 12 1032 Romanel sur-Lausanne Switzerland	UK Authorized Representative MDSS-UK RP 6 Wilmslow Road, Rusholme Manchester M14 5TP United Kingdom
---	---	---

General

Read and understand all instructions prior to the use of the product. Failure to adhere to instructions and warnings in this document may result in property damage, injury, or death. Product misuse or failure to follow instructions will void the warranty.

Immediately discontinue use if any function is compromised, if parts are missing or loose, or if any component shows signs of excessive wear. Consult with your supplier for repair, adjustment, or replacement.

All persons responsible for fitting, adjustment, and daily use of the devices discussed in these instructions must be familiar with and understand all safety aspects of the devices mentioned. In order for our products to be used successfully, you must read and understand all instructions and warnings, and maintain our products according to our instructions on care and maintenance.

The installation instructions will guide you through this product's options and possibilities.

Instructions are written with the expressed intent of use with standard configurations. They also contain important safety and maintenance information, as well as describe possible problems that can arise during use. For further assistance, or more advanced applications, please contact your supplier or **Stealth Products** at (512) 715-9995 or toll free at (800) 965-9229.

Always keep the operating instructions in a safe place so they may be referenced as necessary.

All information, pictures, illustrations, and specifications are based on the product information that was available at the time of printing. Pictures and illustrations shown in these instructions are representative examples and are not intended to be exact depictions of the various parts of the product.

CAUTION

These products are designed to be fitted, applied, and installed exclusively by a healthcare professional trained for these purposes. The fitting, application, and installation by a non-qualified individual could result in serious injury.

Warranty

Our products are designed, manufactured, and produced to the highest of standards. If any defect in material or workmanship is found, Stealth Products will repair or replace the product at our discretion. Any implied warranty, including the implied warranties of merchantability and fitness for a particular purpose, shall not extend beyond the duration of this warranty. **Stealth Products** does not warrant damage due to, but not limited to: misuse, abuse, or misapplication of product, and/or modification of product without written approval from **Stealth Products, LLC**. Any alteration or lack of serial number, where applicable, will automatically void all warranty.

Stealth Products, LLC is liable for replacement parts only. **Stealth Products, LLC** is not liable for any incurred labor costs.

Stealth Products warrants against failure due to defective materials or workmanship:

Covers: 2 years

Hardware: 5 years

Electronics: 3 years

In the event of a product failure covered by our warranty, please follow the procedures outlined below:

Call **Stealth Products** at (512) 715-9995 or toll free at (800) 965-9229.

Request a Return Authorization (RA) form from the Returns Department and follow the documentation instructions.

Additional warranty information may be found by visiting the website at <https://stlpro.site/returns-n-warranty>. Copies of this manual may be downloaded by accessing the Stealth website (<https://stlpro.site/stealth-docs>) and searching "Mushroom Joystick" in the search bar at the top of the page.

Supplier Reference	
Supplier:	
Telephone:	
Address:	
Purchase Date:	
Model:	

Important Information

Warning Labels

Warnings are included for the safety of the user, client, operator, and property. Please read and understand what the signal words **DANGER**, **WARNING**, **CAUTION**, **NOTICE**, and **SAFETY** mean, and how they could affect the user, those around the user, and property.



Identifies an **imminent** situation which, if not avoided, may result in **severe injury, death, and property damage**.



Identifies a **potential** situation which, if not avoided, may result in **severe injury, death, and property damage**.



Identifies a **potential** situation which, if not avoided, may result in **minor to moderate injury and property damage**.

NOTICE

Identifies important information not related to injury, but possible **property damage**.

SAFETY

Indicates steps or instructions for safe practices, reminders of safe procedures, or important safety equipment that may be necessary.

Limited Liability

Stealth Products, LLC accepts no liability for personal injury or damage to property that may arise from the failure of the user or other persons to follow the recommendations, warnings, and instructions in this manual.

Stealth Products does not hold responsibility for final integration of final assembly of product to end user. Stealth Products is not liable for user death or injury.

Testing

Initial setup and driving should be done in an open area free of obstacles until the user is fully capable of driving safely.

Intended Use

The Mushroom Joystick is a proportional joystick that requires standard force and is designed for those individuals who have limited grasping abilities.

Features

The Mushroom Joystick:

- Offers proportional control.
- Can be ordered in a small or large size.
- Has a top designed in a comfortable shape for the user.
- Has an operating force of 226gf (.5 lb-ft)
- Comes in a fixed or swing away version.
- Is compatible with Invacare® (Mk6i, Mark V, Mark IV), Dynamic® (DX), Q-Logic™, and R-net™ electronics.

Mounting

Multiple mounting options are available for the Mushroom Joystick:

- Gatlin Mid-line Mount (MJM260 Series)
- ARMS Mounting Hardware with a fixed mount (MJM250 Series)
- ARMS260 mounting hardware (MJMS250)

User Transfer

- Turn off the power chair and Mushroom Joystick when moving, transferring, or lifting the user.

Moving the Chair

- Turn off the power chair and Mushroom Joystick when moving or transporting the wheelchair.
- Do NOT lift the chair by any Mushroom Joystick component.

Terrain Safety

- Do NOT use on surfaces of which you are unsure.
- Do NOT use on the edge of a stream, lake, or ocean.
- Do NOT use on roads, streets, or high automotive traffic areas.
- Always follow instructions provided by the wheelchair manufacturer about driving on safe surfaces, angles of ascent and descent.

Design and Function

The movements of the joystick are translated into to the movements of the wheelchair, driving, or menu navigation.

Common practice to navigate the wheelchair with the Mushroom Joystick is as follows:

- **Direction:** Press the joystick in the direction you want the wheelchair to move. The wheelchair will move in that direction.
- **Speed:** The further the joystick is moved from the neutral (center) position, the faster the wheelchair will move.
- **Stop:** When the joystick is released, it will return to the neutral (center) position and the wheelchair will stop moving.



CAUTION

Initial setup and driving should be done in an open area, free of obstacles, until the user is fully capable of driving safely.

Joystick Safety

- Do not use if the joystick handle is damaged, missing, or cracked.
- Do not use if the joystick does not return to the neutral position independently.
- Do not use if the joystick does not move to and from the neutral position smoothly.

Comfort and Ergonomics

The shape of the joystick is ideal for resting in the palm of your hand. It offers a unique mechanical and tactile configuration that will amplify minimal force and provides an option for good hand control.

Safe Driving

It is mandatory to have a wheelchair power on/off switch, which immediately shuts down the wheelchair power and electronics, and is within easy reach of the user while driving. This allows the wheelchair to instantly stop in case of problems or an emergency.



WARNING

The on/off switch must be available to the user at all times.



WARNING

In case the wheelchair responds in an unexpected way, the user must immediately release the joystick or use the power switch.

Joystick Operation

The Mushroom Joystick gives the user the ability to operate their wheelchair drive parameters with smooth and precise control.

Prior to Operation

Ensure the wheelchair and Mushroom Joystick are correctly set up and adjusted to the user's needs.

If the Mushroom Joystick does not perform as specified, turn off the wheelchair and repeat setup or contact your supplier or Stealth Products.

Joystick Setup

It is important to properly install the Mushroom Joystick for the user. Take care during the assessment to identify joystick placement, allowing maximum user access and control.

CAUTION

Do not position the joystick where the hand may be obstructed from moving in any direction.

WARNING

An incorrect programming of the wheelchair electronics may cause damage to the devices or injury to the user.

Installation Plan

Prior to programming the chair, set up an installation plan. This plan should take into account:

- Where the mushroom joystick will be placed.
- How the mushroom joystick will be operated.
- The positioning of the joystick. Do not place the joystick where it may be obstructed from moving in any direction.

CAUTION

Refer to the power chair's user manual for important instructions.

Manually disengage the drive motors prior to setting up the chair's electronics.

Always use a slow speed when initially operating the Mushroom Joystick.

Q-Logic™ Handheld Programmer

Navigation

Arrows navigate the main menu. *Up* and *Down* to navigate the menus, *Right* to open a menu item and *Left* to return to the previous menu.

Help Button

Display information about options selected on screen.

Bookmark Buttons

Select options in the main menu. Button actions are displayed on screen above corresponding buttons. In other menus, hold button to Bookmark Settings, and press button to quickly go to bookmark.

Plus and Minus



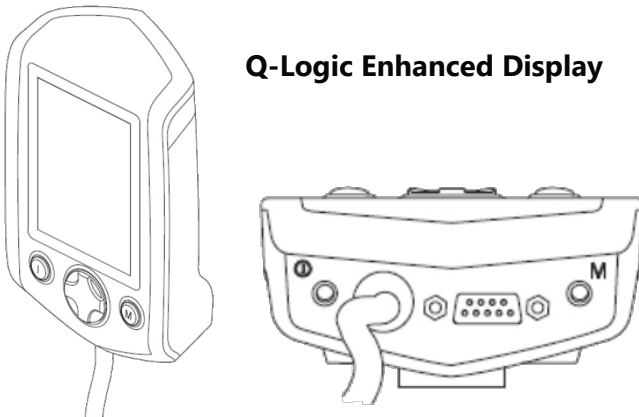

Toggle settings or change the value of the highlighted parameter.



NOTE: Q-Logic™ Enhanced Display and Q-Logic™ Handheld Programmer required.

**WARNING*****Manually disengage drive motors.***

Prior to setting up the power chair's electronics to recognize the input, ensure that the chair's power is off and the motors are manually disengaged. This will prevent unintentional chair movement.

1. Plug in the Q-Logic™ Handheld Programmer to the back of the Q-Logic™ ED (Enhanced Display) or to the standalone joystick if SCIM (Specialty Control Input Module) is in use.
2. Power on the chair.
3. On the Q-Logic™ programmer, navigate to *Program Adjustments*  *Specialty Control*  *Active Device*.
4. Toggle *Active Device* to *Proportional* with the *Plus*  and *Minus*  buttons.
5. Unplug the Q-Logic™ Handheld Programmer and Turn Off the system. The chair should now be programmed to recognize the Mushroom Joystick (Be sure to re-engage the motors when you are finished programming).





NOTICE

If using Q-Logic™ Specialty Control Input Module (SCIM), you will need any type of mechanical switch to plug into the power port of the standalone joystick to power ON/OFF the chair and ensure the SCIM as master control.
Q-Logic™ Programmer required.

NOTICE

For new chairs that have never been programmed, a power cycle will need to be done after the joystick has been calibrated and before the joystick throw can be adjusted.

Q-Logic™ Proportional Joystick Setup







1. Plug in the Q-Logic™ Handheld Programmer to the Q-Logic™ ED (Enhanced Display) or to the standalone joystick if SCIM (Specialty Control Input Module) is in use.
2. On the Q-Logic™ Programmer, navigate to *Program Adjustments*  *Specialty Control*  *Proportional*  *Joystick Set Ups*  *Proportional*. Here you can fine tune joystick performance and functionalities such as:
 - *Center and Axis Deadband*
 - *Tremor Suppression*
 - *Assign Direction*
 - *Joystick Calibration and Throw*
 - *Switch Operation*

**WARNING**

All setups should be performed by a trained technician.







Center Deadband

The *Center Deadband* parameter defines how far the joystick must be deflected from the neutral position to become responsive and start moving the power chair. The value corresponds to the diameter of a circle around the joystick center position. No drive or menu instruction will be executed unless the joystick is moved out of this circle.

- Select *m: Center Deadband* option with the navigation's Up  and Down  buttons, then press the Right  button.
- Use the Plus  and Minus  buttons to adjust the *Center Deadband*. Adjustment ranges from 5 to 50%. Press Left  navigation button to save.







Axis Deadband

The *Axis Deadband* parameter defines how far the joystick has to move to become responsive. This can be helpful if a toggle command has to be made.

- Select *m: Axis Deadband* option with the navigation's Up  and Down  buttons, then press the Right  button.
- Use the Plus  and Minus  buttons to adjust the *Axis Deadband*. Adjustment ranges from 5 to 50%. Press Left  navigation button to save.

Tremor Suppression

The tremor suppression sets a neutral range that suppresses possible tremors (trembling of hand or drive surface conditions) on the joystick. Setting from 0% to 100%.



1. Plug in the Q-Logic™ Handheld Programmer to the back of the Q-Logic™ ED (Enhanced Display) or to the standalone joystick if SCIM (Specialty Control Input Module) is in use.
2. Turn on chair power.
3. Select *m: Tremor Suppression* option with navigation's Up  and Down  buttons, then press the Right  button.
4. Use the Plus  and Minus  buttons to adjust *Tremor Suppression*. To turn back off, adjust to 0%.
5. When done, press Left  navigation button to return to menu and save.

NOTICE

When short command is used to operate the power chair, the Tremor Suppression should not be set over 90%, otherwise the short throw will be ignored.





Assign Direction Function

The *Assign Direction* Function allows you to set the axis direction. For example, if you want to change *Forward* (X axis 0 to 100) to *Reverse* (X axis 0 to -100) or *Left* (Y axis 0 to -100) to *Right* (Y axis 0 to 100). If you switch *Forward* to *Reverse*, the system will automatically change *Reverse* to *Forward*. Same with *Left* and *Right*. Parameters are measured in percent (%).

1. Plug in the Q-Logic™ Handheld Programmer to the back of the Q-Logic™ ED (Enhanced Display) or to the standalone joystick if SCIM (Specialty Control Input Module) is in use.
2. Power on the chair.
3. Select *Assign Direction* option with navigation's Up  and Down  buttons, then press the Right  button. Then follow screen instructions.
4. When done, press OK to save.

Switch Operations

The *Switch Operations* parameter sets the joystick to operate like a switch input, removing its proportionality. When the joystick is moved out of neutral and more than 50% of the operating range, it will activate at full throttle (100%) in the desired direction. *Switch Operations* can be set ON or OFF.



1. Plug in the Q-Logic™ Handheld Programmer to the back of the Q-Logic™ ED (Enhanced Display) or to the standalone joystick if SCIM (Specialty Control Input Module) is in use.
2. Power on the chair.
3. Select *m: Switch Operations* option with navigation's Up  and Down  buttons, then press the Right  button. Then follow screen instructions.
4. When done, press Left  navigation button to return to menu and save.



Calibration MUST be done for the joystick. This a new safety feature update included in the Q-Logic™ Programmers.





Joystick Calibration

Calibrating your joystick will set the range of motion for the axes or re-center it to improve operation.

1. Plug in the Q-Logic™ Handheld Programmer to the back of the Q-Logic™ ED (Enhanced Display) or to the standalone joystick if SCIM (Specialty Control Input Module) is in use.
2. Power on the chair.
3. Select *Calibrate* option with navigation's Up  and Down  button
4. Programmer will prompt for a calibration with the joystick. Press the joystick forward and move it either direction through two full revolutions.
5. Calibration will be complete. Press *OK* to save. Exit Screen.
6. Power cycle the chair.



Joystick Throw

Throw is the location of maximum deflection of a joystick in a particular direction. It can vary by user based on capability. The throw should be based on the ability of the user and set to the maximum deflection the user is capable of producing.





1. Once calibration is complete, Plug in the Q-Logic™ Handheld Programmer to the back of the Q-Logic™ ED (Enhanced Display) or to the standalone joystick if SCIM (Specialty Control Input Module) is in use.
2. Power on the chair.
3. Select *Throw* option with navigation's *Up*  and *Down*  buttons, then press the *Right*  button.
4. This setting will turn power chair's system to *IDLE MODE*, press OK if prompted, then follow screen instructions.
5. Deflect the joystick with individual's maximum force. Adjust the parameters by pressing the *Plus*  and *Minus*  buttons.
6. When it is complete, you will be prompted to save the new configuration. Press *Yes* to save.

Q-Logic 3



Joystick Setup

1. Plug the Q-Logic handheld programmer into the back of the display.
2. On the Programmer, select *Program Adjustments*.
3. In the *Program Adjustments* menu, select *Enhanced Display*.
4. In the *Enhanced Display* menu, select *Input Configuration*.
5. With the *Plus*  and *Minus*  buttons, select *Proportional*.
6. Use the *Left*  navigation button to return to the *Main Menu* and save.



Joystick Calibration

1. Plug the Q-Logic handheld programmer into the back of the display.
2. On the programmer, select *Program Adjustments*.
3. In the *Program Adjustments* menu, select *Enhanced Display*.
4. In the *Enhanced Display* menu, with the *Up*  and *Down*  buttons, select *Proportional Input*.
5. With the *Right*  navigation button, select *Proportional Calibration*. The programmer will read 'Roll the joystick in two full circles.'
6. Select *OK* and verify that calibration was successful.
7. With the *Left*  navigation button, select back until you exit completely.
8. Unplug the programmer and power cycle the chair.





Joystick Throw

1. Plug the Q-Logic handheld programmer into the back of the display.
2. On the programmer, select *Program Adjustments*.
3. In the *Program Adjustments* menu, select *Enhanced Display*.
4. In the *Enhanced Display* menu, with the Up  and Down  buttons, select *Proportional Input*.
5. In the *Proportional Input* folder, Select *Proportional Throw*.
6. Follow the prompts on the programmer.





Assign Direction

1. Plug the Q-Logic handheld programmer into the back of the display.
2. On the programmer, select *Program Adjustments*.
3. In the *Program Adjustments* menu, select *Enhanced Display*.
4. In the *Enhanced Display* menu, with the Up  and Down  buttons, select *Proportional Input*.
5. In the *Proportional Input* menu, select *Proportional Assign Directions*.
6. Follow the prompts on the programmer.





Center Deadband

1. Plug the Q-Logic handheld programmer into the back of the display.
2. On the programmer, select *Program Adjustments*.
3. In the *Program Adjustments* menu, select *Enhanced Display*.
4. In the *Enhanced Display* menu, with the Up  and Down  buttons, select *Proportional Input*.
5. In the *Proportional Input* menu, select *Center Deadband*.
6. With the Plus  and Minus  buttons, adjust the center deadband value.
7. Use the Left  navigation button to exit menu.

Tremor Suppression

1. Plug the Q-Logic handheld programmer into the back of the display.
2. On the programmer, select *Program Adjustments*.
3. In the *Program Adjustments* menu, select *Enhanced Display*.
4. In the *Enhanced Display* menu, with the Up  and Down  buttons, select *Proportional Input*.
5. In the *Proportional Input* menu, select *Tremor Suppression*.
6. With the Plus  and Minus  buttons, adjust the tremor suppression value.
7. Use the Left  navigation button to exit menu after selections have been made.

Switch Operation

1. Plug the Q-Logic handheld programmer into the back of the display.
2. On the programmer, select *Program Adjustments*.
3. In the *Program Adjustments* menu, select *Enhanced Display*.
4. In the *Enhanced Display* menu, with the Up  and Down  buttons, select *Proportional Input*.
5. With the Plus  and Minus  buttons, select *Proportional Switch Op.*
6. Use the Left navigation button to exit the menu after selections have been made.

R-net™ Omni Setup

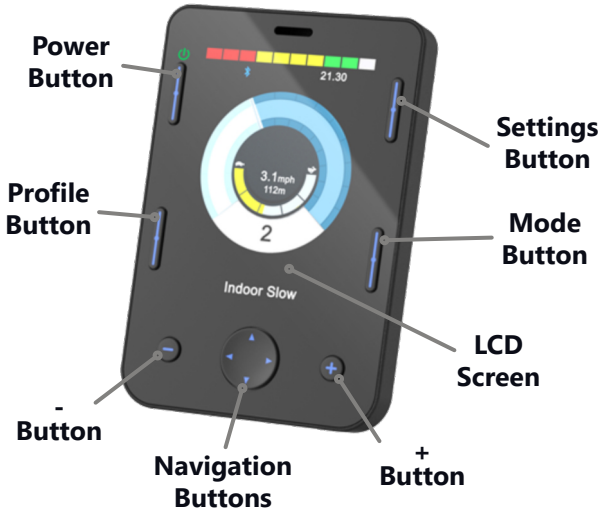

Display / Input Section Connector



R-Net Programming Dongle

R-Net Input Section

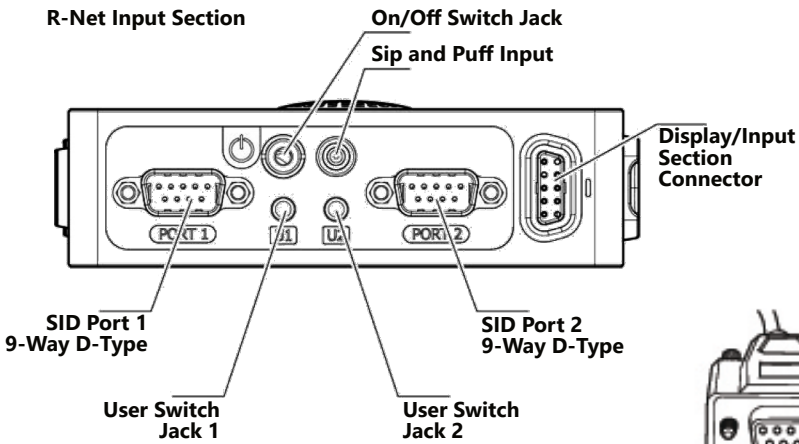

9-Pin Connector

Joystick Recognition

1. Plug in the R-net Programming Dongle in line with the Omni display and the chair's electronics, and then power *ON* the chair.
2. Press the *Mode* button until you reach *OBP* (On Board Programming) menu. The *OBP* menu will appear as an hourglass while loading.
3. Navigate to the *Omni* menu, then navigate to *Omni Port 1* (or *Port 2* if the Joystick is in *Port 2*).
4. In the *Port* menu, toggle *SID* to *Prp* with the *Plus* and *Minus* buttons.
5. In the *Port* menu, navigate to *Switches*.
6. In the *Switches* menu, toggle *Switch Detect* to *Off* with the *Plus* and *Minus* buttons, if a user switch is not utilized.
7. In the *Switches* menu, toggle *9 Way Detect* to *Off* with the *Plus* and *Minus* buttons.
8. Navigate back to the *Omni* menu, and then navigate to *Profiled*.
9. In the *Profiled* menu, configure a profile to use the port for the Mushroom Joystick.
10. Power off the chair, remove the R-net Programming Dongle, reconnect the Omni Display, and power on the chair.
 - The chair should now be programmed to recognize the Mushroom Joystick. Be sure to re-engage the motors before operation.

Joystick Calibration

1. Plug in the R-net Programming Dongle in line with the Omni Display and chair's electronics, then power *ON* the chair.
2. Press the *Mode* button until you reach the *OBP* (Onboard Programming) menu. The *OBP* menu will appear as an hourglass while loading.
3. In the *OBP* menu, select *System*.
4. In the *System* menu, select *Joystick Calibration*.
5. Follow the on-screen instructions.
6. When the calibration is complete, power off the chair. Remove the R-net Programming Dongle, reconnect the Omni Display, and power on the chair.

R-net™ Proportional Joystick Setup

1. Plug in the R-net™ Programming Dongle in line with the Omni Display and chair's electronics, then power on the chair.
2. Press the *Mode* button until you reach the *OBP* (Onboard Programming) menu. The *OBP* menu will appear as an hourglass while loading.
3. With the navigation buttons, navigate to *Controls Joystick*. Here you can fine tune joystick performance and functionalities such as:
 - *Active Throw* and *Active Throw Details/Deadband*
 - *Active Orientation* and *Orientation Details*

Throw

Throw is the location of maximum deflection of a joystick in a particular direction. It can vary by user based on capability. The throw should be based on the ability of the user and set to the maximum deflection the user is capable of producing.

Active Throw

- Plug in the R-net™ Programming Dongle in line with the Omni Display and chair's electronics, then power on the chair.
- Press the *Mode* button until you reach the *OBP* (Onboard Programming) menu. The *OBP* menu will appear as an hourglass while loading.
- Using the navigation buttons, navigate to *Controls*. Press the *Right* button to select it.
- Navigate to *Joystick*. Press the *Right* button to select it.
- Navigate to *Active Throw*, and press the *Right* button to select it.
- Select a profile to edit.
- Follow the on-screen instructions, moving the joystick in the indicated direction to the maximum deflection possible by the user. Press the *Plus* button to save and proceed to the next step. Values range from 25% to 100%, default value is 100%.

Throw Details and Center Deadband

Throw Details will allow you to see *Throw* values for multiple profiles on one screen. To select profiles, use Navigation buttons (*Left* or *Right*), and to select axis, use (*Up* or *Down*). The selected axis/profile can be adjusted by increments of one or in increments of ten using the *Plus* and *Minus* buttons. For increments (or decrements) of ten, keep *Plus* (or *Minus*) button pressed. Values range from 25% to 100%, default is 100%.

Center Deadband (*DBand*) describes the zone around the neutral position of the joystick that is unresponsive to user input. It can be used to create a buffer to absorb unintentional movements for users that have difficulty with fine motor control. Range is 10% - 50%, default value is 10%.

Axis Orientation

The *Axis Orientation* parameter allows you to switch the axis definitions. For example, the X-axis (*Forward/Reverse*) can be switched, making the rear of the chair the *Forward* direction, and vice versa. This allows joysticks to be installed in any position necessary and correspond with the proper direction of movement of the chair.

Active Orientation

- Plug in the R-net™ Programming Dongle in line with the Omni Display and the chair's electronics. Turn on the chair's power.
- Press the *Mode* button until you reach the *OBP* (Onboard Programming) menu. The *OBP* menu will appear as an hourglass while loading.
- With the navigation buttons, navigate to *Controls*. Press the *Right* button to select it.
- With the navigation buttons, navigate to *Joystick*. Press the *Right* button to select it.
- Select *Active Orientation* from the list and press the *Right* button. Select the profile you wish to edit..
- Follow the on-screen instructions.
- Power cycle the chair.

Orientation Details

The *Orientation Details* option is similar to the *Throw Details* option, but it sets the direction of proportional controllers listed in each profile. Values are set to *Yes* or *No* for invert Forward/Reverse (*InvFR*) or Left/Right (*InvLR*). To swap axes, change value on *SWAP* row either *Yes* or *No*. Power cycle the chair.

After the programming of the Mushroom Joystick, execute the following tests, in order, before the wheelchair is delivered or put into service:

- Integrity Test, Operational Test, Test Drive, Stop Test

Integrity Test

Check that the:

- Mushroom Joystick is not bent or damaged;
- Housing, cabling, and all connectors are undamaged; and,
- the joystick returns to its default (center) position when moved and released from the forwards, backwards, left and right positions.

Operational Test

1. Activate the wheelchair operating system.
2. Check for any error message.
3. Move the joystick slowly forward until you hear the parking brakes switch off.



CAUTION

The wheelchair may start to move.

4. Immediately release the joystick. You should hear the brakes react within a few seconds.
5. Repeat steps 3 and 4 three times, while slowly moving the joystick towards you, to the left and to the right.
6. Check whether the Power ON/OFF (Pwr) and Mode (In) switches function properly.

Test Drive

- Perform a test drive with the wheelchair
- Check whether the wheelchair and all of its operations are fully functioning in all positions that the user may use the Mushroom Joystick.
- Check that no cabling or parts may get damaged or hindered in any possible position of the wheelchair.

Stop Test



WARNING

Execute this test only on a level surface, in an open area, free of obstacles.

- Drive at full speed and shut down the wheelchair with the power off button.
- The wheelchair must not stop suddenly, but should slow down to a gradual stop.

Dealer Assistance

During first time use by the client, it is advised that the dealer or service technician assists and explains the different drive configurations to the customer (the user, and/or the attendant.) If needed the dealer can make final adjustments.

User Testing

It is important that the customer is fully aware of the installation, how to use it, and what can be adjusted in order to gain as much mobility as possible. As a dealer, proceed as follows:

- Explain and show the customer how you have executed the installation, and explain the function of the joystick.

Have the user test all positions of the Mushroom Joystick.

- Is the Mushroom Joystick within easy reach?
- Can the user safely operate the wheelchair with minimal effort?
- Is the placement of the joystick in an optimal position for the user?

If needed, adjust the Mushroom Joystick to the proper position.

Explain to the customer possible problems and how to address them.

Conditions of Use

The Mushroom Joystick is intended for use as installed by the dealer, in accordance with the installation instructions in this manual.

- The foreseen conditions of use are communicated by the dealer or service technician to the user and/or attendant during the first time use.
- If the usage conditions change significantly, please contact your dealer or a qualified service technician to avoid excessive wear and tear or unintended damage.

Environment Safety

- Operate or store the Mushroom Joystick in a temperature range of -40° to 149°F (-40° to 65°C).
- Do not operate in or expose the Mushroom Joystick to rain, snow, sleet, hail, or damp environments.
- Do not operate the Mushroom Joystick in the shower.
- Do not operate or store the Mushroom Joystick near open flame, flammable items, or combustible products.

Maintenance Check

- Ensure all cords are securely routed and connected and free of damage or wear.
- Move the joystick through the four quadrants, checking for smooth movement and return to the center position.
- Check all fasteners and tighten as necessary. Avoid damage caused by over-tightening.
- Clean all surfaces and disinfect when necessary.
- Check for changes in the joystick function or performance. This can be achieved by manually testing all the controls or running a diagnostic through the chair's electronics.

Water Contact

- Turn off the chair and disconnect the Mushroom Joystick from the chair.
- Thoroughly dry the Mushroom Joystick with a towel.
- Allow 12 hours to dry in a warm dry place to allow any unseen moisture to evaporate.
- Check that the Mushroom Joystick operates to specifications before use.
- If there are changes in the function or performance of the joystick, contact the dealer.

Cleaning

- The joystick may be wiped clean with a damp cloth and a mild, non-abrasive cleaner.
- Ensure cleaners are approved for steel, aluminum, plastic, and upholstered surfaces.
- Do not immerse in water or rinse with a water hose.

Electromagnetic Interference (EMI)

The Mushroom Joystick has been tested to a radiation immunity level of 20 volts per meter.

Electronics may be susceptible to EMI, the interfering energy emitted from sources such as radio stations, TV stations, radio transmitters, and cellular phones. The interference from radio waves may cause malfunctions and equipment damage.

Dimensions

- | | | |
|------------------------|----------------|-------------------|
| ▪ Small Configuration: | Knob Diameter: | 1.97 in (5cm) |
| | Knob Height: | 1in (2.54cm) |
| | Box Height: | 2.67 in. (6.78cm) |
| ▪ Large Configuration | Knob Diameter: | 2.5 in. (6.35cm) |
| | Knob Height: | 1.65 in. (4.19cm) |
| | Box Height: | 4.25 in. (10.8cm) |

Required Force

- Required Force: 226gf (.5 lbf)



© 2023, Stealth Products, LLC

Warranty Information



Home Page



Online User Manual

