



## Foot Support

# Foot Positioners

## Intended Use

The **Stealth Positioning™** line of pelvic belts, vests, chest straps and foot positioners are intended to help wheelchair users attain proper alignment of the torso, pelvis and feet. Comfort, stability and improved clinical posture are achieved through the use of breathable material and structured support.

Foot positioning impacts proper seating and safety. Foot positioners provide flex and stretch, enabling the individual to benefit from movement within a controlled range and helping to balance the lower body in response to upper body movements. Correct foot positioning results in:

- Increased stability for function;
- Sustained hip and knee positioning;
- Increased foot protection;
- Improved foot circulation;
- The elimination of posterior pelvic tilt; and,
- Easier self-positioning.

# Installation and Use

## Foot Positioner Ankle Strap Installation

**Step 1:** With the center buckle facing towards the toe of the foot plate, thread the strap of the ankle support through one of the rear set of side slots on the foot plate.

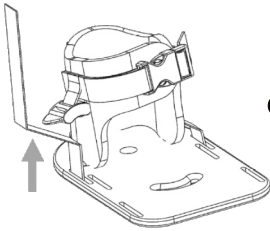

STEP 1

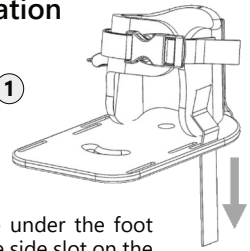

**Step 2:** Guide the strap under the foot plate and up through the side slot on the opposite side of the plate.

**Step 3:** Guide the end of the strap up through the tri-slide buckle. Slide the strap through the space closest to the buckle first.

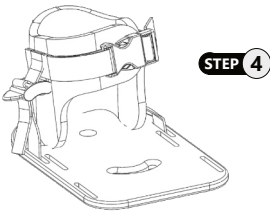

STEP 4

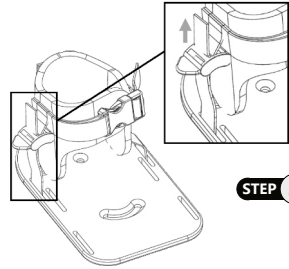

STEP 3

**Step 4:** Thread the strap over the post and back under and through the buckle. Pull the strap completely through, ensuring the strap is tight and secure.

**Step 5:** To attach the back strap to the base of the foot plate, guide the webbing through the back slot and pull through.

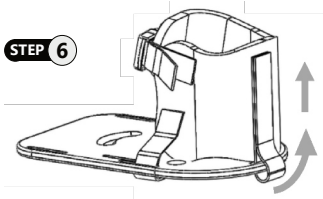

STEP 6

STEP 5

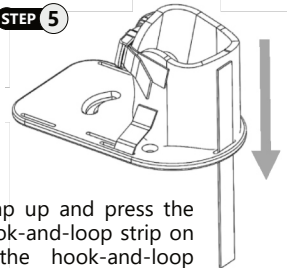

**Step 6:** Pull the strap up and press the strap against the hook-and-loop strip on the pad. Secure the hook-and-loop section and check that it is securely fastened.

## Foot Positioner Toe Strap Installation

**Step 1:** Thread the toe strap webbing through one of the side slots on the front of the foot plate.

**Step 2:** Guide the webbing under the foot plate and back up through the slot on the opposite side of the plate.

**Step 3:** Thread the webbing under and through the elastic strap sewn onto the pad, and up through the tri-slide, guiding it through the space closest to the buckle first.

**Step 4:** Slide the webbing over the post, under and through the second gap of the buckle. Pull the strap completely through, ensuring the strap is tight and secure.

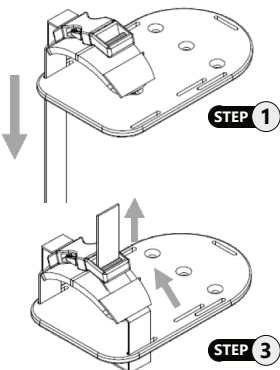

STEP 1

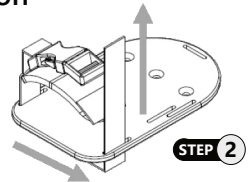

STEP 2

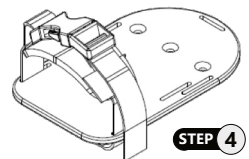

STEP 4

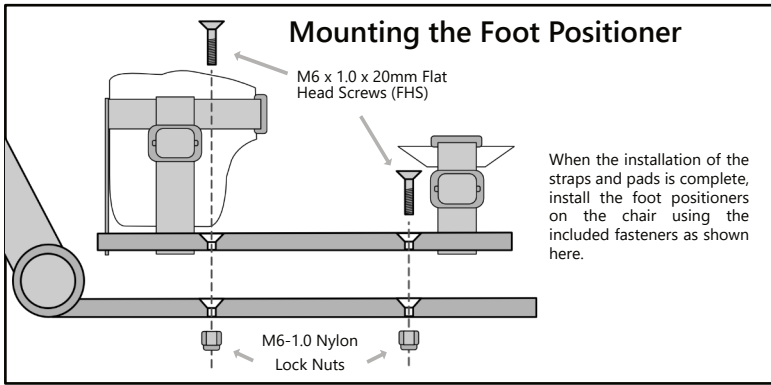

## For Ankle Supports without a Foot Plate

For an installation of ankle supports without an additional footplate, modification of the wheelchair's existing footplate will be necessary.

1. Position the ankle support in the approximate position in which it will be mounted. Using the screw holes in the footman loop as a template, mark the centers of the mounting holes in the footman loops with a pen or awl. Using a drill and 11/64", or #17 drill bit, drill the marked holes into the footplate.
2. Insert the M4 x 0.7 x 22mm Flat Head Screws through the holes in the footman loops, through the footplate, and finish with a M4 Flat Washer and M4 Nylon Lock Nut. Tighten the screws to secure the footman loop to the footplate.
3. Install a 3/4" Slide to the strap by threading the strap through the slide from the rear and back through the front. Slide the strap through the footman loop, and back up through the slide, as shown the image to the right. Repeat for the other straps to complete the installation.

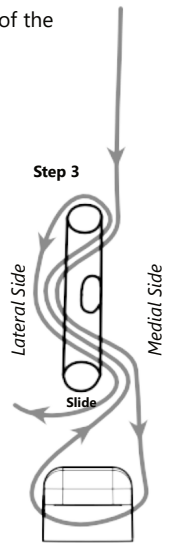
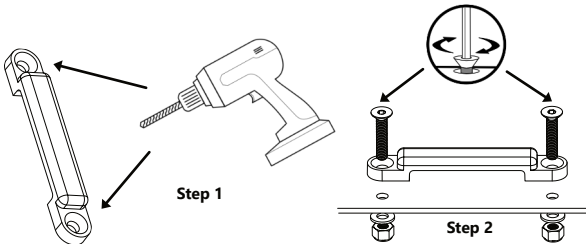

**Footman's Loop**  
Thread the strap through the footman loop and slide as shown here.

## Care and Cleaning

We recommend that all products be examined on a regular basis for wear and function. Check the stitching on the webbing for stress or damage. If loose, frayed or broken parts are discovered, discontinue use and contact your provider. Repairs should only be performed by a wheelchair service professional and with genuine **Stealth Products** parts, fasteners or items appropriate for the service required.

Surfaces may be cleaned with a damp cloth and a mild, non-abrasive cleaner. Ensure all cleaners are approved for finished steel, aluminum, plastic and upholstered surfaces. Vests and straps that are removable and DO NOT contain metal components may be machine washed warm (40°C), permanent press cycle, mild process.

**DO NOT bleach. DO NOT tumble dry. Dry flat. DO NOT iron.**

## Important

Never use a foot positioner without a positioning belt. Positioning belts and supports should only be used to help support the user's posture. The belts, posture supports and straps must be snug, but must not interfere with the user's breathing. Check to make sure the user cannot slide down in the seating system, as they may suffer chest compression and may suffocate due to pressure from the belts or harnesses. A seat with angle or built-in contours may help prevent the user from sliding in the seat. Due to the possibility of a user sliding while in-chair, unsupervised use of anterior thoracic support devices could pose a serious choking hazard. Continually ensure that the user is sitting upright and that the thoracic support device does not obstruct the user's breathing in any way.

These devices do not conform to ANSI/RESNA WC20 or SAE J2249 and are not designed or approved to provide restraint or protection in the event of a crash. Wheelchair users should transfer to a vehicle seat and use the vehicle seat belt system or a child safety seat that complies with federal safety standards. The wheelchair should then be stored and secured in the vehicle. Children weighing less than 48 lbs. must always transfer to an approved child safety seat.

Before you install or begin using any product from **Stealth Products' Stealth Positioning™** line, it is important that you read and understand the content of these installation and operating instructions. Product misuse due to failure to adhere to instructions and warnings in this document will void your warranty and may result in property damage, injury or death. Always keep the operating instructions in a safe place so they may be referenced as necessary. If this document contains information you do not understand or if there are concerns about safety or operation, contact your provider.

All information, pictures, illustrations and specifications are based on the product information available at the time of printing, and are representative examples. They are not intended to be exact descriptions of the various parts of the product. Instructions are written with the expressed intent of use with standard configurations. They also contain important safety and maintenance information. For assistance with advanced configurations or options, contact your provider or **Stealth Products** at (512) 715-9995 or toll free at (800) 965-9229.

Immediately discontinue use if any function is compromised, if parts are missing or loose or if any component shows signs of excessive wear. Consult with your provider for repair, adjustment or replacement. You can download additional copies of this manual by visiting <https://stlpro.site/stealth-docs/> and searching for "Stealth Positioning" in the document manager.

## Warranty

Our products are designed, manufactured, and produced to the highest of standards. If any defect in material or workmanship is found, **Stealth Products** will repair or replace the product at our discretion. Any implied warranty, including the implied warranties of merchantability and fitness for a particular purpose, shall not extend beyond the duration of this warranty. **Stealth Products, LLC** does not warrant damage due to, but not limited to, misuse, abuse, or misapplication of products and modification of product without written approval from **Stealth Products, LLC**.

Any alteration or lack of serial number, where applicable, will automatically void this warranty. **Stealth Products, LLC** is liable for replacement parts only. **Stealth Products, LLC** is not liable for any incurred labor costs. No person is authorized to alter, extend, or waive the warranties of **Stealth Products, LLC**.

To learn more about our warranty and returns policy, please visit <https://stlpro.site/returns-n-warranty>.

## About Us

**Stealth Products** is committed to 100% customer satisfaction. Your complete satisfaction is important to us. Please contact us with suggestions or feedback to help us improve the quality and usability of our products.

You may reach us at:

 **Stealth Products, LLC**  
104 John Kelly Drive,  
Burnet, TX 78611

Phone: (512) 715-9995 Toll Free: (800) 965-9229  
Fax: (512) 715-9954 Toll Free: (800) 806-1225  
[info@stealthproducts.com](mailto:info@stealthproducts.com) - [www.stealthproducts.com](http://www.stealthproducts.com)

<b>EC REP</b> <b>MDSS GmbH</b> Schiffgraben 41 30175 Hannover, Germany	<b>CH REP</b> <b>SODIMED SA</b> Chemin Praz Devant 12 1032 Romanel sur-Lausanne, Switzerland	<b>UK Authorized Representative</b> <b>MDSS-UK RP</b> 6 Wilmslow Road, Rusholme Manchester M14 5TP, United Kingdom
---------------------------------------------------------------------------------	-------------------------------------------------------------------------------------------------------	-----------------------------------------------------------------------------------------------------------------------------

