

# ALTERNATIVE DRIVE CONTROL ORDER FORM

## Client Information

PO#:<sup>1</sup>

Branch:

Date:

Contact:

E-mail<sup>2</sup>:

Phone:<sup>2</sup>

## Mobility Base Information

Manufacturer:

Model:

Serial:

Fax:

Mark for:

Order Type\*:  Quote  Order

**\* Required Fields**  
 1. Required if this is an order  
 2. One of the options is required

This order uses Adobe Acrobat® interactive technology and we recommend you to use latest version of Acrobat Reader® after downloading and saving the form to your desktop local drive.

**\* US Only. HCPCS codes provided should not be considered as legal advice and do not guarantee reimbursement.**

## MO-VIS JOYSTICKS & ACCESSORIES

### MO-VIS JOYSTICKS

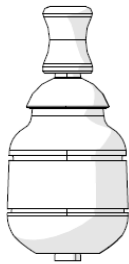

- **mo-Vis Micro** ..... \$3,492.16  
Part: IDM-MICRO-9 HCPCS: E2312
- **mo-Vis Micro Rnet BUS**..... \$3,463.95  
Part: IDM-MICRO-R

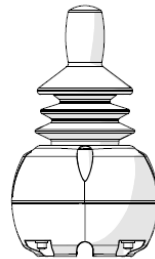

- **mo-Vis All Round** ..... \$1,703.36  
Part: IDM-ALLROUND-9 HCPCS: E2373
- **mo-Vis All Round, Rnet BUS** ..... \$1,703.36  
Part: IDM-ALLROUND-R
- **mo-Vis All Round Lite**..... \$1,946.70  
Part: IDM-ARLITE-9 HCPCS: E2373
- **mo-Vis HD** ..... \$2,703.75  
Part: IDM-HD

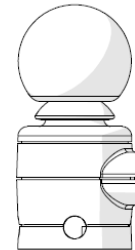

- **mo-Vis Multi** ..... \$3,492.16  
Part: IDM-MULTI-9 HCPCS: E2312
- **mo-Vis Multi Rnet BUS, Rnet BUS** ..... \$3,492.16  
Part: IDM-MULTI-R
- **mo-Vis All Round Lite, Rnet BUS** ..... \$2,110.50  
Part: IDM-ARLITE-R

### MO-VIS MOUNTING

#### Micro Mounting Options

- **Tray and Mount (Right)**..... \$511.01  
Part: GAT440M-51M-R
- **Tray and Mount (Left)** ..... \$511.01  
Part: GAT440M-51M-L
- **GAT Palm Tray & Mount**..... \$425.84  
Part: GAT441-MICRO
- **GAT Mount, Micro**..... \$198.72  
Part: GAT451M
- **Swing Away Mount**..... \$283.90  
Part: SM651
- **SM600 Mount** ..... \$170.34  
Part: SM600-651
- **Accessory Pack**..... \$141.68  
Part: M006-20
- **Ball Topper** ..... \$141.68  
Part: M006-08
- **Cup Topper** ..... \$141.68  
Part: M006-09

#### All Round Mounting Options

- **GAT Mnt for All Round** ..... \$141.95  
Part: GAT472P-M
- **Hardware Assembly**..... \$283.90  
Part: SM660-M
- **Mounting Set**..... \$221.71  
Part: M002-61
- **Chin Ball Topper**..... \$141.68  
Part: M002-76
- **Knob Topper** ..... \$68.13  
Part: M002-74
- **Swing Away Mount for All Round** ..... \$312.28  
Part: ARMS260-AR

#### Mounting Options

- **GAT Mount** ..... \$198.72  
Part: GAT461M
- **Hardware Assembly**..... \$283.90  
Part: SM661M
- **SM600 Mount** ..... \$170.34  
Part: SM600-661
- **Accessory Pack**..... \$141.68  
Part: M002-18
- **Ball Topper** ..... \$141.68  
Part: M002-05
- **Gatlin Palm Tray**..... \$425.84  
Comes with Mount  
Part: GAT441-MULTI

#### Foot Control Options

- **Mo-Vis Foot Control** ..... \$4,830.00  
Part: P021-51
- **Foot Control Safety Bracket** ..... \$598.50  
Part: M021-61

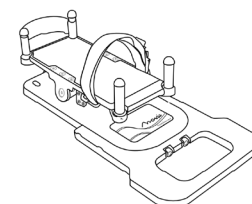

Mo-Vis Mounting Cables continued on Next Page

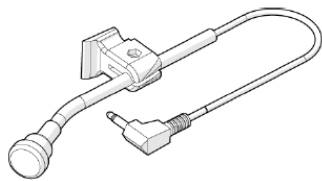

Satellite

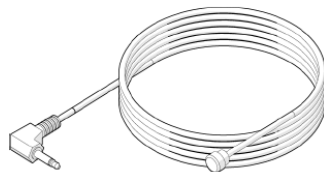

Basic Button

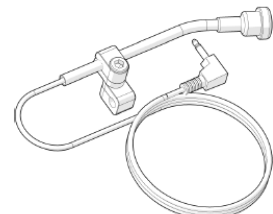

On Bent Tube

**Twisters**

Only compatible with All Round and All Round Lite Joysticks

- **Black** .....\$448.82  
Part: P005-40
- **Red** .....\$448.82  
Part: P005-41
- **Yellow** .....\$448.82  
Part: P005-42
- **Blue** .....\$448.82  
Part: P005-43
- **Green** .....\$448.82  
Part: P005-44

**Long Cable (1500mm)**

For Basic Button

- **Black** .....\$312.55  
Part: P005-70
- **Red** .....\$312.55  
Part: P005-71
- **Yellow** .....\$312.55  
Part: P005-72
- **Blue** .....\$312.55  
Part: P005-73
- **Green** .....\$312.55  
Part: P005-74

**Long Cable (1500mm)**

For On Bent Tubes

- **Black** .....\$448.61  
Part: P005-50
- **Yellow** .....\$448.61  
Part: P005-52
- **Blue** .....\$448.61  
Part: P005-53
- **Green** .....\$448.61  
Part: P005-54

**TWISTER PRO SWITCHES**

**Twister Pro Long Cable (1500mm)**

- **Black** .....\$309.75  
Part: P030-11
- **Red** .....\$309.75  
Part: P030-12
- **Green** .....\$309.75  
Part: P030-13

**Twister Pro Short Cable (300mm)**

- **Black** .....\$309.75  
Part: P030-21
- **Red** .....\$309.75  
Part: P030-22
- **Green** .....\$309.75  
Part: P030-23

**Twister Gooseneck (1500mm)**

Twister on flexible 400mm gooseneck

- **Black** .....\$457.80  
Part: P018-20
- **Red** .....\$457.80  
Part: P018-21
- **Green** .....\$457.80  
Part: P018-24
- **Q2M Universal Clamp** .....\$203.70  
Part: M007-01

**Short Cable (300mm)**

- **Black** .....\$242.03  
Part: P005-15
- **Red** .....\$242.03  
Part: P005-16
- **Yellow** .....\$242.03  
Part: P005-17
- **Blue** .....\$242.03  
Part: P005-18
- **Green** .....\$242.03  
Part: P005-19

**TWISTER BASIC BUTTON DOME**

**Long (1500mm)**

- **Black** .....\$194.67  
Part: P005-75
- **Red** .....\$194.67  
Part: P005-76
- **Yellow** .....\$194.67  
Part: P005-77
- **Blue** .....\$194.67  
Part: P005-78
- **Green** .....\$194.67  
Part: P005-79

**Short (300mm)**

- **Black** .....\$293.48  
Part: P005-85
- **Red** .....\$293.48  
Part: P005-86
- **Yellow** .....\$293.48  
Part: P005-87
- **Blue** .....\$293.48  
Part: P005-88
- **Green** .....\$293.48  
Part: P005-89

**Twist & Swing**

Combination of a Q2M Manual Swing with Twister on Bent Tube

- **Black** .....\$838.95  
Part: P005-90
- **Red** .....\$838.95  
Part: P005-91
- **Yellow** .....\$838.95  
Part: P005-92
- **Blue** .....\$838.95  
Part: P005-93
- **Green** .....\$838.95  
Part: P005-94

**MO-VIS HAND WARMING OPTIONS**

- **mo-Vis Hand Warmer Set** .....\$973.35  
Part: P012-62
- **mo-Vis Hand warmer Dome, (2 hands)** .....\$432.60  
Part: M012-31
- **mo-Vis Hand warmer Dome, (1 hand)** .....\$577.50  
Part: M012-33

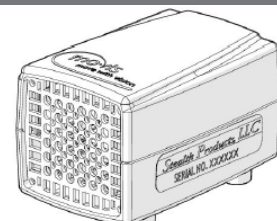

Mo-Vis Accessories continued on Next Page

Mark For:

PO:

**MO-VIS ACCESSORIES**

**Multi Swing 2G**

- **Multi Swing 2G Arm**..... \$4,239.90  
Includes the multi Swing 2G motor unit, Q2M Joint Arm Assembly & Q2m Multi Swing 2G Adapter Set  
Part: P031-61
- **Multi Swing 2G Track Mount**..... \$714.53  
Part: M031-93
- **Multi Swing 2G Cane/Tube Mount**..... \$714.53  
Part: M031-99

**Chin Boom JS Mounts**

- **Joystick, Adjustable Joint**..... \$243.60  
Part: M004-40
- **Multi Joystick Chin Control Adapter** ..... \$277.73  
Part: M004-51
- **All Round Joystick Chin Control Adapter** ..... \$340.20  
Part: M004-52

**Manual Swing 2G**

- **Manual Swing 2G** ..... \$2,008.65  
Part: P031-21
- **Manual Swing Mounting Set**..... \$838.43  
Part: M004-17

**MULTI SWITCH OPTIONS**

**Multi Switch Inputs and Outputs**

- **Multi Switch Proximity Sensor Input Set** ..... \$1188.57  
Part: IDM-MS-SS  
Note: All Twister, egg Switch, Mini Cup and Micro-lite switches are also compatible for inputs.
- **Male to Male Switch Extension** ..... \$55.44  
Requires one for each output used.  
Part: ES-EXT-MM
- **Stereo to Mono Splitter** ..... \$96.60  
Part: PMCAB00027

**Multi Switch Options**

- **Multi Switch**..... \$838.16  
Part: IDM-MS  
Notes:  
Requires input switches or multi switch sensors.  
Requires output cables for each output used.

**MO-VIS CHIN CONTROLS**

**Chin Control Harness**

- **Chin Control Harness**..... \$1,836.45  
Part: M013-61

**Chin Control Harness Accessories**

- **Multi Adjustable Joint**..... \$243.60  
Part: M004-40
- **Multi Joystick Adapter** ..... \$277.73  
Part: M004-51
- **All Round Joystick Adapter** ..... \$340.20  
Part: M004-52

**STEALTH PRECISION MINI PROPORTIONAL JOYSTICK**

Please select a topper and mounting option when ordering a joystick.

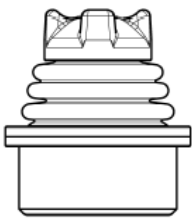

**Castle Topper**..... \$ 3,492.16  
Part: IDPMP-9-CA HCPCS: E2312

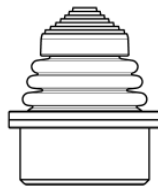

**Cone Topper**..... \$3,495.16  
Part: IDPMP-9-CO HCPCS: E2312



**Finger Tip Topper** ..... \$ 3,492.16  
Part: IDPMP-9-FT HCPCS: E2312

**Mounting Options**

- Stealth PMPJ Mount for Swing-Away Hardware** ..... \$283.90  
Part: SM670
- Stealth PMPJ Mount for Gatlin** ..... \$148.71  
Part: GAT486
- Stealth PMPJ Swing-Away Joystick Mount** ..... \$312.28  
Part: ARMS260-PMPJ
- Stealth PMPJ Mount for Gatlin, 360 Degree Swivel** ..... \$208.19  
Part: GAT497
- 4" x 6.5" Center Tray w/ PMPJ Mount** ..... \$425.84  
Part: GAT441-PMP
- 4" x 6.5" Left Tray w/ PMPJ Mount** ..... \$425.84  
Part: GAT441-PMP-L
- 4" x 6.5" Right Tray w/ PMPJ Mount** ..... \$425.84  
Part: GAT441-PMP-R

Stealth Control Accessories Continued on Next Page

# I-DRIVE CONTROL HARNESES

## Step 1: Select Size

- **Pediatric** .....\$936.58  
Part: IDCH-P
- **Small** .....\$936.58  
Part: IDCH-S

- **Medium** .....\$936.58  
Part: IDCH-M
- **Large** .....\$936.58  
Part: IDCH-L

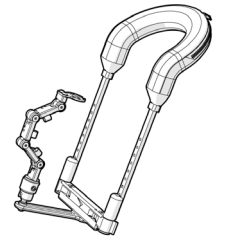

## Step 2: Select Belt Size

- **Standard Belt**  
Standard option for IDCH-P, S & M  
Part: IDCH-SB
- **Extra Large Belt**  
Standard option for IDCH-L, Optional for IDCH-M  
Part: IDCH-XLB

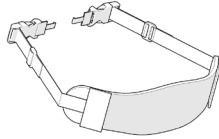

## Step 3: Select Mounting

- **Mount for IDM-MULTI-9, IDPMP-1-9**  
Part: IDCH-JM01
- **Mount for IDM-MICRO-9**  
Part: IDCH-JM02

## I-DRIVE CONTROL MOUNT ACCESSORIES

- **6 inch Flex tube for mounting accessories** ..... \$45.42  
Part: IDCH-FL6
- **Fiber Optic on Flex Tube (requires IC24F-1), Left** ...\$312.55  
Part: IDCH-AFL
- **Fiber Optic on Flex Tube (requires IC24F-1), Right..** \$312.55  
Part: IDCH-AFR
- **Single Twister Basic Button on Flex Tube, Left** .....\$448.82  
Part: IDCH-A1L Select color below

- **i-Connect 24V Interface & 1 Fiber Optic Sensor**..... \$766.78  
Must select a power source if ordering IC24F-1  
Part: IC24F-1
- **i-Connect Power Source for Q-Logic** ..... \$317.96  
Part: IC24PS-QL
- **i-Connect Power Source for R-Net Electronics**..... \$317.96  
Part: IC24PS-RN
- **Additional Link for Harness**..... \$57.32  
Part: IDCH-LINK
- **Single Twister Basic Button on Flex Tube, Right**....\$448.82  
Part: IDCH-A2R Select color below

**Black**  
Part: P005-70

**Red**  
Part: P005-71

**Blue**  
Part: P005-72

**Yellow**  
Part: P005-73

**Green**  
Part: P005-74

## I-DRIVE CONTROL REPLACEMENT PARTS

- **Mounting for Multi, PMPJ 1 & 9** ..... \$57.32  
Part: IDCH-JM01
- **Mounting for Micro** .....\$85.44  
Part: IDCH-JM02
- **Replacement Standard Belt** ..... \$110.31  
Part: IDCH-SB
- **Replacement Extra Large Belt** ..... \$110.31  
Part: IDCH-XLB

- **Replacement Track Bar Kit for IDCH-L**.....\$135.19  
Part: IDCH-LTB
- **Replacement Track Bar Kit for IDCH-M** .....\$135.19  
Part: IDCH-MTB
- **Replacement Track Bar Kit for IDCH-P** .....\$135.19  
Part: IDCH-PTB
- **Replacement Track Bar Kit for IDCH-S**.....\$135.19  
Part: IDCH-STB

	Collar Size	Min. Circumference	Max Circumference
IDCH-SP	Pediatric	27 in. (68.58 cm)	42 in. (106.68 cm)
	Small	30 in. (76.20 cm)	45 in. (144.30 cm)
	Medium	33 in. (83.82 cm)	48 in. (121.92 cm)
IDCH-XLB	Medium	36 in. (91.44 cm)	51 in. (129.54 cm)
	Large	39 in. (99.06 cm)	69 in. (175.26 cm)

**i-Drive Belts**

IDCH-P (Pediatric)		IDCH-S	
Max. Neck Width	Max. Neck Circumference	Max. Neck Width	Max. Neck Circumference
3.5in (8.89 cm)	11in (27.94 cm)	4.5in (11.43 cm)	14in (35.56 cm)
Arm Length	Lateral Adjustment	Arm Length	Lateral Adjustment
7in (17.78 cm)	3in (7.62 cm)	9in (22.86 cm)	4in (10.16 cm)

IDCH-M		IDCH-L	
Max. Neck Width	Max. Neck Circumference	Max. Neck Width	Max. Neck Circumference
5.5in (13.97 cm)	17.25in (43.81 cm)	6.5in (16.51 cm)	20.5in (52.07cm)
Arm Length	Lateral Adjustment	Arm Length	Lateral Adjustment
10in (25.40 cm)	5in (10.16 cm)	11in (27.94 cm)	6in (12.70 cm)

Muchroom Joysticks, see Next Page

Mark For:

PO:

## MUSHROOM JOYSTICK

### Gatlin Mounts

- Mushroom with Gatlin mount for Permobil** ..... \$2,696.99  
Part: MJM260-P
- Mushroom with Gatlin mount for Quantum or Quickie** ..... \$2,696.99  
Part: MJM260Q

### Swing-Away Mounts

- Mushroom with Swing-Away mount for Permobil** ..... \$2,327.93  
Part: MJMS250P
- Mushroom with Swing-Away mount for Quantum or Quickie**..... \$2,327.93  
Part: MJMS250Q

### i-Drive Mounts

- Mushroom with i-Drive Fixed mount**..... \$5,353.43  
Part: IDHBTMJM250-1  
\* Includes IDHBT500-17mm i-Drive interface and fixed mounting

### Fixed Mounts

- Mushroom with Fixed Hardware for Permobil** ..... \$2,157.59  
Part: MJM250P
- Mushroom with Fixed Hardware for Quantum or Quickie**..... \$2,157.59  
Part: MJM250Q

## I-DRIVE ALTERNATE DRIVE CONTROLS

### I-DRIVE TRI-ARRAY SYSTEM HCPCS: E2330

- Tri-Array Head Support** ..... \$4,773.74  
Part: IDHBT200-U
- Pediatric Tri-Array Head Support**..... \$4,773.74  
Part: IDHBT250-U

#### Packages Include:

- Tri-Array Head Support (E0955)
- 3 Proximity Sensors
- Non-proportional, egg switch for reset mode change (E2330)
- i-Drive Interface



Refer to page 9 for mounting hardware selection

**Call Stealth Products for additional support and advanced configurations.**

### I-DRIVE PRO SERIES SYSTEM

- Pro Series Head Support** ..... \$4,824.57  
Part: IDHBT300-U
- Pediatric Pro Series Head Support**..... \$4,824.57  
Part: IDHBT350-U

#### Packages Include:

- Occipital Pads (E0955)
- SAR2B-B HW Bilateral Swing-Away Hardware (E1028)
- Pro Series Head Support (E0955)
- 3 Proximity Sensors
- non-proportional, egg switch for reset mode change
- i-Drive Interface
- 2 Spot Pads- Choose Size:

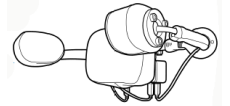

**3 in x 2 in**  
Part: 910M

**4.5 in x 2 in**  
Part: 900M

### I-DRIVE CURVED TRI-ARRAY SYSTEM HCPCS: E2330

- Adult Curved Head Array** ..... \$4,773.74  
Part: IDHBT400-U
- Junior Curved Head Array**..... \$4,773.74  
Part: IDHBT450-U

#### Packages Include:

- Curved Tri-Array Head Support (E0955)
- 3 Proximity Sensors
- Non-proportional, egg switch for reset mode change
- i-Drive Interface

\*\* SAR2B Swing-Away required to mount switch to headrest

### MISCELLANEOUS

- Cervical Extension Inhibit Switch**..... \$85.44  
Part: IDHM-CE-1

#### Reset Egg Switch Color

Standard Egg Switch Color is Black

#### Black

Part: ESBLK

#### Blue

Part: ESBLU

#### Green

Part: ESGRN

#### Red

Part: ESRED

#### Yellow

Part: ESYEL

### I-DRIVE SWING-AWAYS

- Swing-Away (E1028)\*\*** ..... \$318.23  
Left Part: SAR2B-L Right Part: SAR2B-R
- Bi-Lateral Swing-Away (E1028)\*\*** ..... \$358.73  
Part: SAR2B-B

\*\* The SAR2B is included and not available for mounting additional switches or pads on the Ultra Pro only (IDHBT300-U)  
^ Figure 8 Bracket required for mounting additional switches and pads on the Pro Series or Tri-Array / Curved Tri-Array w/ swing away hardware.

### RESET EGG SWITCH MOUNTING

#### None

- On Swing-Away Hardware\*\*** ..... \$289.31  
Part: F8675M

- Knee Add. Fixed (K0108)** ..... \$244.15  
Pick size below

#### 1 inch

Part: KN1ADD

#### 1 1/4 inch

Part: KN1ADD-1 1/4

#### 1 3/8 inch

Part: KN1ADD-1 3/8

- Knee Add. Swing-Away w/Track Mount (K0108)**..... \$266.86  
Part: KN1ADD-TRK

\*\* The SAR2B Swing-Away or F8675M Figure 8 must be ordered for this option.

i-Drive Alternate Drive Controls continued on Next Page

ADDITIONAL PROXIMITY SWITCHES (K0108)

**L R Proximity Sensor for SAR2B** ..... \$595.91  
 Part: IDHBT501

**L R Proximity Sensor for F8675M** ..... \$595.91  
 Part: IDHBT501

Select pad to cover switch:

**No Pad**                      **900 4.5x2"**                      **910 3x2"**  
 Part: 900M                      Part: 910M

**L R Fiber Optic** ..... \$709.46  
 Part: IDH503

Select mount for Fiber Optic:

**Swing-Away Mount**.....\$340.67  
 Part: F0660

**Pad Mount**.....\$340.67  
 Part: F0650

**Tray Mount**.....\$170.34  
 Part: F0690



ADDITIONAL MECHANICAL SWITCHES (K0108)

**L R Embedded Mini Cup Switch for SAR2B** ..... \$302.82  
 Part: MC220

**L R Sip & Puff for SAR2B** ..... \$318.23  
 Part: SP625M

**L R Embedded Mini Cup Switch for F8675M** ..... \$302.82  
 Part: MC220

**L R Egg Switch for SAR2B** ..... \$87.44  
 Choose color below

**L R Tash Mini Cup Switch for SAR2B** ..... \$210.89  
 Part: MC210

**L R Egg Switch for F8675M** ..... \$87.44  
 Choose color below

**L R Tash Mini Cup Switch for F8675M** ..... \$210.89  
 Part: MC210

Select Egg Switch Color:

<b>Black</b>	<b>Blue</b>	<b>Green</b>	<b>Red</b>	<b>Yellow</b>
Part: ESBLK	Part: ESBLU	Part: ESGRN	Part: ESRED	Part: ESYEL

**L R Tash Micro-Lite Switch for SAR2B** ..... \$210.89  
 Part: ML210

**Bluetooth Dongle Cable** ..... \$85.44  
 Part: IDHA-BT

**L R Tash Micro-Lite Switch for F8675M** ..... \$210.89  
 Part: ML210

TRAY-ARRAY SERIES I-DRIVE CONTROL SYSTEM

**Proximity Sensor Tray Array\*** ..... \$5,904.99  
 Part: IDT100-1

**Tray Array, 3 Fiber Optic Sensor\*** ..... \$4,940.29  
 Part: IDTF100-1

**Package Includes:**

- GAT440 Hollow Eclipse Tray (K0108)
- IDHBT500-17MM i-Drive Interface
- GAT419 360 degree Tray Mount
- 4 non-proportional proximity switch mechanisms
- Egg switch for reset mode change (E2330)

**Package Includes:**

- GAT440 Hollow Eclipse Tray (K0108)
- IDHBT500-17MM i-Drive Interface
- GAT419 360 degree Tray Mount
- 3 fiber optic proximity switch mechanisms
- Egg switch for reset mode change (E2330)

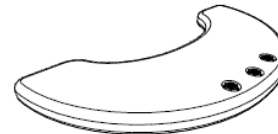

**Tray Array, 4 Fiber Optic Sensor\*** ..... \$5,280.96  
 Part: IDTF100-2

**Package Includes:**

- GAT440 Hollow Eclipse Tray (K0108)
- IDHBT500-17MM i-Drive Interface
- GAT419 360 degree Tray Mount
- 4 fiber optic proximity switch mechanisms
- Egg switch for reset mode change (E2330)

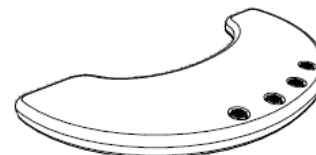

\* Refer to page 11 to select GAT mid line mounting system for trays.

i-Drive Alternate Drive Controls continued on Next Page

**HEAD POSITIONING & HEADREST HARDWARE (E1028)**

**Link Style Hardware**..... \$311.33

Part: UHB2D33200

**Link Hardware with Offset Square Tubing**..... \$311.33

Part: UHB6D33200

**Link Style Hardware with Flip Down**..... \$381.21

Part: UHB2D232FD

**Hardware Parts & Replacements**

HCPCS: K0108

**HMO Series Flip Down Mount**..... \$170.34

Part: FDM350

**Additional 3" Link**.....\$81.06

Part: UILNK300

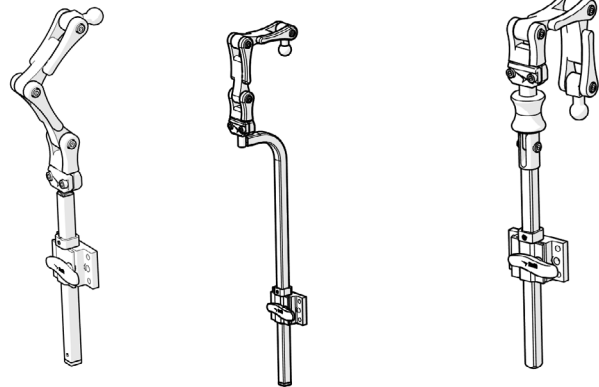

**I-DRIVE SIP & PUFF SYSTEM**

**Tri-Array Head Support w/Sip & Puff** .....\$5,086.29

Part: IDHBT210-U

**Pro-Series Head Support w/Sip & Puff** ..... \$5,137.13

Part: IDHBT310-U

**Package Includes:**

- Tri-Array Head Support (E0955) w/ Sip & Puff
- 3 Proximity Sensors
- non-proportional, egg switch for reset mode change (E2330)
- i-Drive Interface

**Package Includes:**

- Occipital Pad
- SUR2B-B Bilateral Swing-Away Hardware (E1028)
- Pro Series Head Support w/ Sip & Puff
- 3 Proximity Sensors
- non-proportional, egg switch for reset mode change (E2330)
- i-Drive Interface

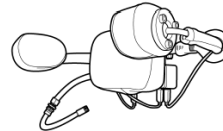
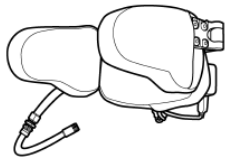

**Pediatric Tri-Array Head Support W/ sip & Puff** ..... \$5,199.85

Part: IDBHT260-U

**Pediatric Pro-Series Head Support w/Sip & Puff**..... \$5,137.13

Part: IDHBT360-U

**I-DRIVE SIP & PUFF ACCESSORIES**

**Replacement Straws (Set of 12)**..... \$34.71

Part: SP625-S12

**Clear Tubing for Sip & Puff** ..... \$109.94

Part: SP625-CT

**Replacement Straw** .....\$14.47

Part: SP625-S

**Replacement Sip & Puff Filter** .....\$17.36

Part: SP625-F

**I-CONNECT FOR MANUAL BASES (12V)**

**Proximity Sensor\***

**Proximity 12V w/Single Mono Plug\***..... \$664.04

Part: IC12P-1

**Proximity 12V w/Dual Mono Plug\*** ..... \$1095.56

Part: IC12P-2

**Fiber Optic Sensor\***

**Fiber Optic 12V w/Single Mono Plug\***..... \$766.78

Part: IC12F-1

\* Requires 12V Power Source

**Sip & Puff^**

**Sip & Puff w/Dual Mono Plug^** ..... \$539.67

Part: ICSNP-2

^ Does NOT Require a Power Source

**i-Connect Power Source 12V**

**12V Battery & Charger for i-Connect** ..... \$335.27

Part: IC12A-BC

**I-CONNECT FOR POWER BASES (24V)**

**Proximity Sensor\***

**Proximity 24V w/Single Mono Plug\***..... \$664.04

Part: IC24P-1

**Proximity 24V w/Dual Mono Plug\*** ..... \$1095.56

Part: IC24P-2

**Fiber Optic Sensor\***

**Fiber Optic 24V w/Single Mono Plug\*** ..... \$766.78

Part: IC24F-1

\* Requires 24V Power Source

**Sip & Puff^**

**Sip & Puff w/Dual Mono Plug^** ..... \$539.67

Part: ICSNP-2

^ Does NOT Require a Power Source

**i-Connect Power Source 24V**

**Power Source for Q-Logic Electronics**.....\$317.96

Part: IC24PS-QL

**Power Source for R-Net Electronics** .....\$317.96

Part: IC24PS-RN

i-Drive Alternate Drive Controls continued on Next Page

Mark For:

PO:

**I-DRIVE ALTERNATE DRIVE CONTROLS CONTINUED**

**I-DRIVE PRECISION MINI PROPORTIONAL JOYSTICK**

Please select a topper and mounting option when ordering a joystick. Includes IDHBT500 i-Drive Interface with egg switch for reset / mode change.

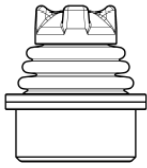

**Castle Topper**..... \$4287.07  
Part: IDPMP-1-CA HCPCS: E2312

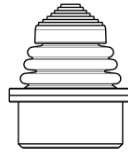

**Cone Topper**..... \$4287.07  
Part: IDPMP-1-CO HCPCS: E2312



**Finger Tip Topper**..... \$4287.07  
Part: IDPMP-1-FT HCPCS: E2312

**Mounting Options**

- Stealth PMPJ Mount for Swing-Away Hardware** ..... \$283.90  
Part: SM670
- Stealth PMPJ Mount for Gatlin** ..... \$148.71  
Part: GAT486
- Stealth PMPJ Swing-Away Joystick Mount for IDPMP** .... \$312.28  
Part: ARMS260-PMPJ
- Stealth PMPJ Mount for Gatlin, 360 Degree Swivel** ..... \$208.19  
Part: GAT497

- 4" x 6.5" Center Tray w/ PMPJ Mount** ..... \$425.84  
Part: GAT441-PMP
- 4" x 6.5" Left Tray w/ PMPJ Mount** ..... \$425.84  
Part: GAT441-PMP-L
- 4" x 6.5" Right Tray w/ PMPJ Mount** ..... \$425.84  
Part: GAT441-PMP-R

**ENVIRONMENTAL CONTROL UNIT**

**9-Pin Cable w/ 3 Mono Plugs**.....\$141.68  
Part: IDHA-ECU3

**9-Pin Cable w/ 4 Mono Plugs**..... \$153.57  
Part: IDHA-ECU4

**REPLACEMENT ITEMS**

- Dongle Cable - Bluetooth**..... \$85.44  
Part: IDHA-BT
- i-Drive Bluetooth Interface** ..... \$1423.25  
Part: IDHBT500

**i-Drive Bluetooth Interface, 17MM ring included**..... \$1423.25  
Part: IDHBT500-17MM

**SUB-OCCIPITAL PAD**

UHBSU23200 and Ultra Mounting Hardware are required to attach a sub-occipital pad

**Unilink Ultra** ..... \$311.59  
Part: UHBSU23200 HCPCS: E1028

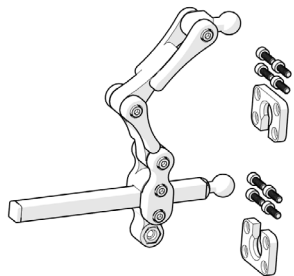

**Sub-Occipital Pads**

- Ultra 8" x 2.75" Medium Sub-Occipital Pad**.....\$57.68  
Part: 600M HCPCS: K0108
- Ultra 10" x 2.75" Large Sub-Occipital Pad**..... \$60.56  
Part: 620M HCPCS: K0108

**i2i Sub-Occipital Pads**

- Low Profile i2i for Sub-Occipital Pad**..... \$367.09  
[Select size below](#)
- Small** Part: I2I455M
- Medium** Part: I2I555M
- Large** Part: I2I655M
- X-Large** Part: I2I755M

**Chin Prompts**

- Chin Prompt**..... \$86.79
- Trachea Chin Prompt** .....\$115.72

**Stealth Ultra Mounting Hardware**

- Link Style Hardware**..... \$169.95  
Part: UHB2D33200-QCR
- Link Hardware with Offset** ..... \$169.95  
Part: UHB7F33200-QCR
- Link Hardware with FDM**..... \$338.78  
Part: UHB2D23FD-QCR

Peripheral Mounts continued on Next Page

Mark For:

PO:



**PERIPHERAL MOUNTS**

**GATLIN MIDLINE MOUNT; 8 POSITION**

- Gatlin 8 Position Armrest Mount for Quantum or Quickie** ..... \$652.95  
Part: GAT400Q
- Gatlin 8 Position Armrest Mount for Invacare** ..... \$652.95  
Part: GAT400I
- Gatlin 8 Position Armrest Mount for Permobil** ..... \$652.95  
Part: GAT400P

**INVACARE ELECTRONIC MOUNTS**

- Invacare Mark VI MPJ Mount** ..... \$141.95  
Part: GAT427I
- Invacare Mark VI MPJ Mount (w/360 °)** ..... \$221.43  
Part: GAT428I
- Invacare Mark VI PSF Mount (w/360 °)** ..... \$221.43  
Part: GAT429I
- Invacare Display Mount (w/360 °)** ..... \$249.83  
Part: GAT495I
- Invacare Mk VI Display Mount (w/360 °)** ..... \$249.83  
Part: GAT496I
- ASL MEC Joystick Mount** ..... \$141.95  
Part: GAT483
- ASL Pediatric Compac Joystick Mount** ..... \$141.95  
Part: GAT480R

**UNILINK HARDWARE**

- UniLink J/S Mount Flip Down, Q-Logic** ..... \$405.71  
Part: UDC2633260
- UniLink Tablet Mount** ..... \$625.28  
Part: URPKTB0000

**GATLIN TRAYS/ACCESSORIES**

- Hollow Partial Eclipse Tray (w/360 °)** ..... \$170.34  
Part: GAT440
- Solid Partial Eclipse Tray (w/360 °)** ..... \$227.12  
Part: GAT440S
- Hollow Mini Tray (w/360 °)** ..... \$425.84  
Part: GAT441
- Solid Partial eclipse Tray w/Mini Joystick Mount (w/360 °)**..... \$539.40  
Left Part: GAT440M-L right Part: GAT440M-R
- Solid Mini Tray w/ASL Joystick Mount (w/360 °)** ..... \$425.84  
Part: GAT441AM

**SWING-AWAY HARDWARE**

- Swing-Away w/Egg Switch Mount**..... \$283.90  
Part: ARMS260
- Invacare MK VI Display Swing-Away Mount**..... \$283.90  
Part: ARMS260-I
- Q-Logic Display Swing-Away Mount**..... \$283.90  
Part: ARMS260-QL
- Omni Plus Display Swing-Away Mount** ..... \$283.90  
Part: ARMS260-P

**MOUNTS FOR PERIPHERAL MOUNTS**

- Height Adjustable Cane Mount for 3/4" Mounts**..... \$141.95  
Part: ARM250-S
- Height Adjustable Flat Mount w/ Track Nuts for Permobil 5/8"Mounts** ..... \$141.95  
Part: ARM250-P
- Height Adjustable Cane Mount for Permobil 5/8" Mounts** ..... \$141.95  
Part: ARM250-PC
- Height Adjustable Cane Mount for Invacare 7/8"Mounts**..... \$141.95  
Part: ARM250-I
- Height Adjustable Mount w/ Flat Bracket for 3/4" Mounts** ..... \$141.95  
Part: ARM250-3/4"FM
- Non-Adjustable Track Mount w/Track Nuts for 3/4" Mounts**.....\$85.17  
Part: ARM240-T

**GATLIN MIDLINE MOUNT; 3 POSITION**

- 3/4 " Gatlin 3 Position Armrest Mount for Quantum or Quickie** ..... \$652.95  
Part: GAT405Q
- 3/4 " Gatlin 3 Position Armrest Mount for Invacare**..... \$652.95  
Part: GAT405I
- 3/4 " Gatlin 3 Position Armrest Mount for Permobil** ..... \$652.95  
Part: GAT405P

**QUANTUM ELECTRONIC MOUNTS**

- Curtis Stand Alone Joystick Mount** ..... \$141.95  
Part: GAT452Q
- Stand Alone Joystick Mount (w/360 °)** ..... \$198.72  
Part: GAT453Q
- Q-Logic Joystick Mount** ..... \$141.95  
Part: GAT456Q
- Q-Logic Joystick Mount (w/360 °)** ..... \$198.72  
Part: GAT457Q
- Quantum HMC-Compact Joystick Mount** ..... \$141.95  
Part: GAT473Q
- Q-Logic Display Swivel Mount (w/360 °)** ..... \$198.72  
Part: GAT495QL

**PERMOBIL ELECTRONIC MOUNTS**

- Permobil R-Net Joystick Mount** ..... \$141.95  
Part: GAT435-RN
- Permobil Compact Light Mount (w/360 °)** ..... \$221.43  
Part: GAT458P
- Permobil Compact Light Mount** ..... \$141.95  
Part: GAT472P-M

- Solid Mini Tray (w/360 °)** ..... \$255.51  
Part: GAT441S
- Tablet Mount (w/360 °)** ..... \$425.84  
Part: GAT444-IP
- Gatlin Egg Switch Mount** ..... \$141.95  
Part: GAT-ESM

- Cellular Device Swing-Away Mount**..... \$283.90  
Part: ARMS260-UNI2
- Small Tablet Swing-Away Mount**..... \$454.23  
Part: ARMS260-TAB
- Invacare MPJ Swing-Away Mount** ..... \$312.28  
Part: ARMS260-MPJ
- ASL MEC Joystick Swing-Away Mount** ..... \$312.28  
Part: ARMS260-MEC

**HYBRID DRIVING PACKAGES**

**IDA1H (PACKAGE 1)**

**\$5,849.09**

**mo-Vis All Round Joystick Lite**

Part: DM-ARLITE-9 HCPCS: E2373

**mo-Vis Satellite Twister-Red**

Part: PO05-41

**Swing-Away Joystick Mount for All Round**

Part: ARMS260-AR

**900 Stealth Ultra Standard Lateral Pad**

Part: 900M HCPCS: K0108

**Comfort Plus Medium 10in. Headrest with Back Pad with Ring**

Part: CP10CCFPM

**Comfort Plus 1" s/a Assm Both Sides w/ Qty - 2 9" Rods**

Part: SAR2A-B

**Features 1" Ball, Square Tubing on Vertical Bar**

Part: UHB6D33200

**Adjustable Knee Adductor Package w/ Track Nut**

Part: KN1ADD-TRK

**Swing away for IDM -Allround-9**

Part: SM660-M

**Stealth Hybrid Driving Package Tackle Box**

Part: IDAH-TBOX

**3" Knee Adductor Pad**

Part: KN1ADD3

**Height Adjustable Mount w/Flat Fixed Bracket**

Part: ARMS250-3/4"FM HCPCS: K0108

**All Round Chin Ball**

Part: M002-76

**Interface Plate For Permobil CS3G Back**

Part: SBM300P

**Lateral Pelvic Universal Track Nut**

Part: LPHW403

**Track Nut for TB3 Armrest**

Part: ARMS-TB3

**Track Nut for Permobil CSG3 Armrest**

Part: ARMS-HW-TNP

**Additional Options for IDA1H Package (package 1)**

**Add Mo-Vis Multi-Swing 2G.....\$ 4,239.38**

Part: P031-61

**I-Drive Control Harness, Small.....\$936.58**

Part: IDCH-S

**I-Drive Control Harness, Medium.....\$936.58**

Part: IDCH-M

**I-Drive Control Harness, Large.....\$936.58**

Part: IDCH-L

**IDA2H (PACKAGE 2)**

**\$8,189.00**

**mo-Vis All Round Joystick Lite**

Part: DM-ARLITE-9 HCPCS: E2373

**mo-Vis Satellite Twister-Red**

Part: PO05-41

**mo-Vis Satellite Twister-Black**

Part: PO05-40

**Swing-Away Joystick Mount for All Round**

Part: ARMS260-AR

**Comfort Plus nino - 6" Headrest Pad with Ring**

Part: CP06CCFPM

**TWB485-17mm Headrest Hardware**

Part: UHB6D33200

**SUN 17mm Nino s/a Assm Both Sides w/ Qty-2 6"**

Part: SAR2A-B

**Adjustable Knee Adductor Package w/ Track Nut**

Part: KN1ADD-TRK

**Swing away for IDM -Allround-9**

Part: SM660-M

**Stealth Hybrid Driving Package Tackle Box**

Part: IDAH-TBOX

**KN1ADD3 Knee Adductor Pad 3"**

Part: KN1ADD3

**Height Adjustable Mount w/Flat Fixed Bracket**

Part: ARMS250-3/4"FM HCPCS: K0108

**All Round Chin Ball**

Part: M002-76

**Interface Plate For Permobil CS3G Back**

Part: SBM300P

**Lateral Pelvic Universal Track Nut**

Part: LPHW403

**Track Nut for TB3 Armrest**

Part: ARMS-TB3

**Track Nut for Permobil CSG3 Armrest**

Part: ARMS-HW-TNP

**900 Stealth Ultra Standard Lateral Pad**

**Note: Make with long cable**

Part: IDHBT900 HPCS: K0108

**i-Drive Bluetooth Head Control Interface**

Part:IDHBT500

**Additional Options for IDA2H Package (package 2)**

**Add Mo-Vis Multi-Swing 2G.....\$ 4,239.38**

Part: P031-61

**I-Drive Control Harness, Small.....\$936.58**

Part: IDCH-S

**I-Drive Control Harness, Medium.....\$936.58**

Part: IDCH-M

**I-Drive Control Harness, Large.....\$936.58**

Part: IDCH-L

**IDA3H (PACKAGE 3)**

**\$ 9,792.92**

**mo-Vis All Round Joystick Lite**

Part: DM-ARLITE-9 HCPCS: E2373

**mo-Vis Satellite Twister-Red**

Part: PO05-41

**mo-Vis Satellite Twister-Black**

Part: PO05-40

**Swing-Away Joystick Mount for All Round**

Part: ARMS260-AR

**Comfort Plus nino - 6" Headrest Pad with Ring**

Part: CP06CCFPM

**TWB485-17mm Headrest Hardware**

Part: UHB6D33200

**i-Drive Bluetooth Stealth Pro Series 3-Proximity**

Part: IDBT300-U

**Adjustable Knee Adductor Package w/ Track Nut**

Part: KN1ADD-TRK

**Swing away for IDM -Allround-9**

Part: SM660-M

**Stealth Hybrid Driving Package Tackle Box**

Part: IDAH-TBOX

**3" Knee Adductor Pad**

Part: KN1ADD3

**Height Adjustable Mount w/Flat Fixed Bracket**

Part: ARMS250-3/4"FM HCPCS: K0108

**All Round Chin Ball**

Part: M002-76

**Interface Plate For Permobil CS3G Back**

Part: SBM300P

**Lateral Pelvic Universal Track Nut**

Part: LPHW403

**Track Nut for TB3 Armrest**

Part: ARMS-TB3

**Track Nut for Permobil CSG3 Armrest**

Part: ARMS-HW-TNP

**Additional Options for IDA3H Packae (package 3)**

**Add Mo-Vis Multi-Swing 2G.....\$ 4,239.38**

Part: P031-61

**I-Drive Control Harness, Small.....\$936.58**

Part: IDCH-S

**I-Drive Control Harness, Medium.....\$936.58**

Part: IDCH-M

**I-Drive Control Harness, Large.....\$936.58**

Part: IDCH-L